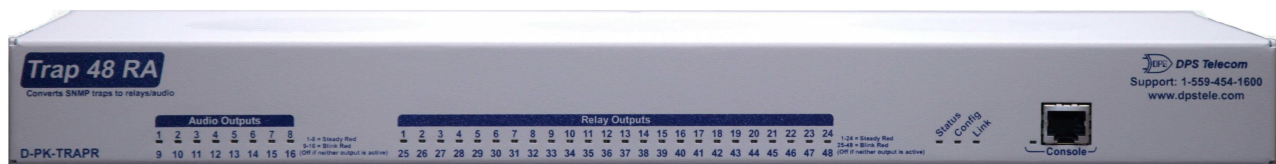


# Trap 48 RA G1 and G2

## USER MANUAL



Visit our website at [www.dpstelecom.com](http://www.dpstelecom.com) for the latest PDF manual and FAQs.

## Revision History

June 7, 2017	Added G2 Supplemental Section
December 16, 2013	Added play count and parse to Edit>Audio screen
July 25, 2013	Removed HTTPS
January 21, 2013	Added relay specification option to Edit>Audio menu
December 12, 2012	Initial release

This document contains proprietary information which is protected by copyright. All rights are reserved. No part of this document may be photocopied without prior written consent of DPS Telecom.

All software and manuals are copyrighted by DPS Telecom. Said software and manuals may not be reproduced, copied, transmitted or used to make a derivative work, by either mechanical, electronic or any other means in whole or in part, without prior written consent from DPS Telecom, except as required by United States copyright laws.

© 2017 DPS Telecom

### Notice

The material in this manual is for information purposes and is subject to change without notice. DPS Telecom shall not be liable for errors contained herein or consequential damages in connection with the furnishing, performance, or use of this manual.

# Contents

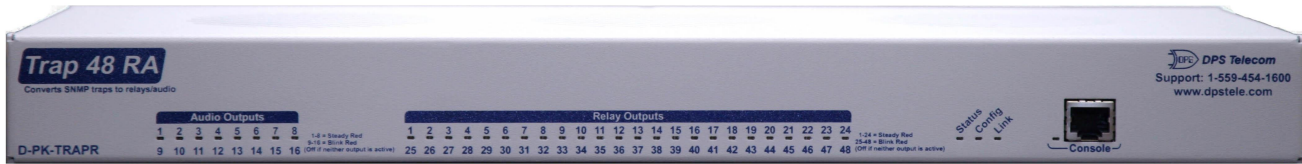
---

Visit our website at [www.dpstele.com](http://www.dpstele.com) for the latest PDF manual and FAQs

<b>1</b>	<b>Trap 48 RA Overview</b>	<b>1</b>
<b>2</b>	<b>Specifications</b>	<b>3</b>
<b>3</b>	<b>Shipping List</b>	<b>4</b>
<b>4</b>	<b>Installation</b>	<b>6</b>
4.1	Tools Needed	6
4.2	Mounting	6
<b>5</b>	<b>Trap 48 RA Back Panel</b>	<b>7</b>
5.1	Power Connection	7
5.2	LAN Connection	8
5.3	Relay Outputs RJ-45 Connectors	8
5.4	Audio Output Connectors	10
<b>6</b>	<b>Trap 48 RA Front Panel</b>	<b>11</b>
6.1	RJ-45 Console Port	11
<b>7</b>	<b>Quick Start: How to Connect to the Trap 48 RA</b>	<b>12</b>
7.1	...via RJ-45 Console Port (using TTY Interface)	12
7.2	...via LAN (First Time Connection to a Unit at Factory Defaults)	13
<b>8</b>	<b>TTY Interface</b>	<b>14</b>
<b>9</b>	<b>Trap 48 RA Web Browser</b>	<b>15</b>
9.1	Logging on to the Trap 48 RA	15
9.1.1	Changing the Default Password	16
<b>10</b>	<b>Trap 48 RA - Quick Turn Up</b>	<b>17</b>
10.1	How to Configure Trap Parsers for an Output	17
10.2	G2: How to Configure Trap Parsers for an Output	19
10.3	Useful Tools	22
<b>11</b>	<b>Provisioning Menu Field Descriptions</b>	<b>23</b>
11.1	System	23
11.2	Ethernet	24
11.3	Controls	26
11.3.1	Configuring Granular OID	27
11.4	Audio	29
11.5	System Alarms	31
11.6	Ping Targets	32
11.7	Notifications	33
11.7.1	Notification Settings	34
11.7.2	Schedule	36
11.7.3	How to Send Email Notifications	37

11.8	Variable Bindings	41
11.9	Load Audio Files in G2 Firmware	41
11.10	Date and Time	42
11.11	Timers	43
<b>12</b>	<b>Reboot</b>	<b>44</b>
<b>13</b>	<b>Monitoring via the Web Browser</b>	<b>45</b>
13.1	Controls	45
13.2	Audio	46
13.3	System Alarms	47
13.4	Ping Targets	48
<b>14</b>	<b>Firmware Upgrade</b>	<b>49</b>
<b>15</b>	<b>Reference Section</b>	<b>50</b>
15.1	Front and Back Panel LEDs	50
15.2	Display Mapping	52
15.3	SNMP Manager Functions	52
15.4	SNMP Granular Trap Packets (Outbound)	53
<b>16</b>	<b>Frequently Asked Questions</b>	<b>55</b>
16.1	General FAQs	55
16.2	SNMP FAQs	56
<b>17</b>	<b>Technical Support</b>	<b>57</b>
<b>18</b>	<b>End User License Agreement</b>	<b>58</b>

# 1 Trap 48 RA Overview

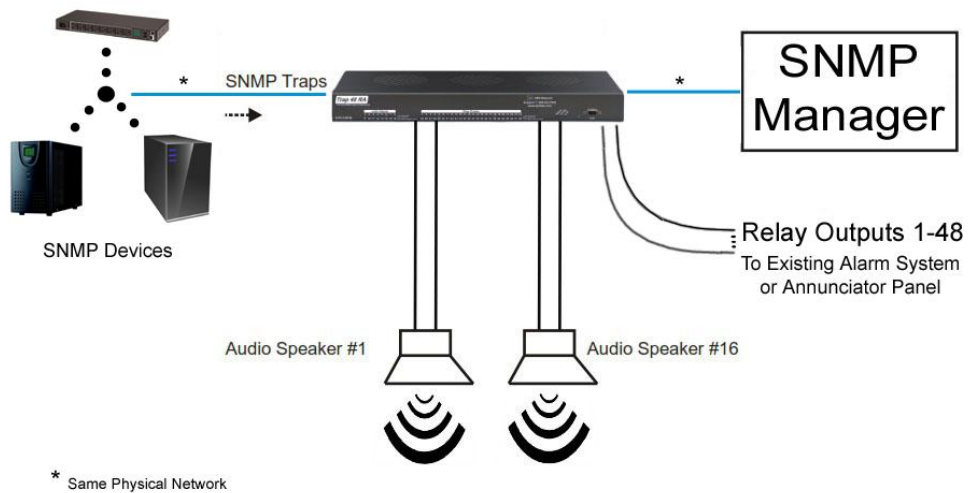


**Fig. 1.1** The easy-to-install Trap 48 RA operates up to 48 relays and 16 audio outputs

## Overview

The Trap 48 RA is a device that operates up to 48 relays and 16 audio outputs using received SNMP trap information. The user can configure each relay to operate or release based on the enterprise, generic-trap, and specific-trap information of a SNMP v1 trap or the trap OID of a SNMP v2c trap. Each SNMP trap can also be defined by an optional variable binding. This telco-grade remote is housed in a durable aluminum chassis that uses one standard rack units for mounting.

- 48 Relay Outputs
- 16 Audio Outputs
- 64 Ping Targets



## Convenient RJ-45 connectors are used to securely terminate relay and audio outputs

On the back panel of the Trap 48 RA, the 28 RJ-45 connectors securely terminate the relay and audio outputs. There are four relays grouped per RJ-45, and one audio per RJ-45 connector.

## Visual alarm interface

The front panel LED indicators provide visual indication of relay point and audio output status. Two outputs share one LED (ex. 1/25, 2/26 etc.). LEDs that are on indicate active outputs. LEDs that are off indicate inactive outputs.

**Web Browser Interface**

From the device's easy-to-use web interface, you do all of the configuration setup tasks like reversing the relay energize state , or selecting audio message, on an individual output basis. Additionally, from the web interface you are able to view the status of all the outputs.

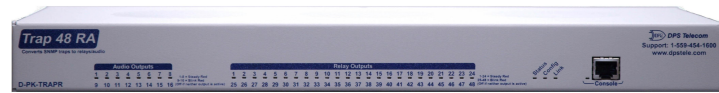
## 2 Specifications

<b>Control Relay Outputs:</b>	48
<b>Audio Outputs:</b>	16
<b>DB Range:</b>	-25 dBm to 5 dBm Software Selectable (-10 dBm default, 600 Ohm balance pair)
<b>Ping Targets:</b>	64
<b>Protocols:</b>	Telnet, ICMP, DCPX, SNMPv1, SNMPv2c*, HTTP
<b>Dimensions:</b>	1.72" H x 17" W x 7.38" D
<b>Weight:</b>	3 lbs 4 oz
<b>Mounting:</b>	19" or 23" rack mount
<b>Power Input</b>	
<b>Voltage Options Include:</b>	Dual Feed +12 VDC
<b>Current Draw:</b>	600 mA @ 12 Vdc 300 mA @ 24 Vdc 150mA @ 48 Vdc
<b>GMT Fuse:</b>	1 Amp GMT Fuse (recommended)
<b>Interfaces:</b>	28 RJ-45 Ports for Audio/Relay Outputs 1 RJ-45 10BaseT half-duplex Ethernet port 1 RJ-45 Front-panel console RS232 port
<b>Visual Interface:</b>	36 Front Panel LEDs 5 Back Panel LEDs
<b>Operating Temperature:</b>	32° to 140° F (0° to 60° C)
<b>Operating Humidity:</b>	0% to 95% non-condensing
<b>MTBF:</b>	60 years
<b>Windows Compatibility:</b>	Windows XP, Vista, 7 32/64 bit
<b>RoHS:</b>	5/6

\*The Trap 48 RA can only process inbound SNMP v2c traps; it can't send v2c traps, but can send v1 traps.

### 3 Shipping List

Please make sure all of the following items are included with your Trap 48 RA. If parts are missing, or if you ever need to order new parts, please refer to the part numbers listed and call DPS Telecom at **1-800-622-3314**.



**Trap 48 RA User Manual**  
**D-UM-TRAPR**

**Trap 48 RA**  
**D-PK-TRAPR**



**14 ft. Ethernet Cable**  
**D-PR-923-10B-14**



**6 ft. RJ45 to DB9 Cable**  
**D-PR-1051-10A-06**



**23" Rack Ears**  
**D-CS-325-10A-01**



**19" Rack Ears**  
**D-CS-325-10A-00**



x8

**3/8" Ear Screws and Lock Washers**  
**2-000-60375-05**



x4

**Rack Screws**  
**1-000-12500-06**





x4

**Metric Rack Screws**  
**2-820-80750-03**



**Pads**  
**2-015-00030-00**



x 3

**1 Amp GMT Fuses**  
**2-741-01000-00**



x 2

**Lg. Locking Power Connectors**  
**2-820-35102-00**



**Keps Nut (on unit)**  
**2-002-01421-00**



x 4

**Zip Ties**  
**1-012-00106-00**

## 4 Installation

### 4.1 Tools Needed

To install the Trap 48 RA, you'll need the following tools:



**Phillips No. 2 Screwdriver**



**Small Standard No. 2 Screwdriver**



**PC with terminal emulator,  
such as HyperTerminal**

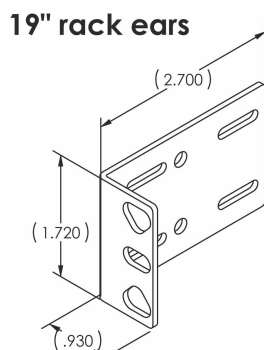
### 4.2 Mounting



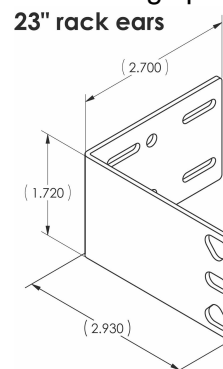
**Fig. 4.1** The Trap 48 RA can be flush or rear-mounted

The Trap 48 RA occupies one standard rack unit. The Trap 48 RA mounts in a 19" or 23" rack, and can be mounted on the right or left, in the flush-mount or rear mount locations, as shown in Fig. 4.1.

The rack ears can be rotated 90° for wall mounting or 180° for other mounting options.

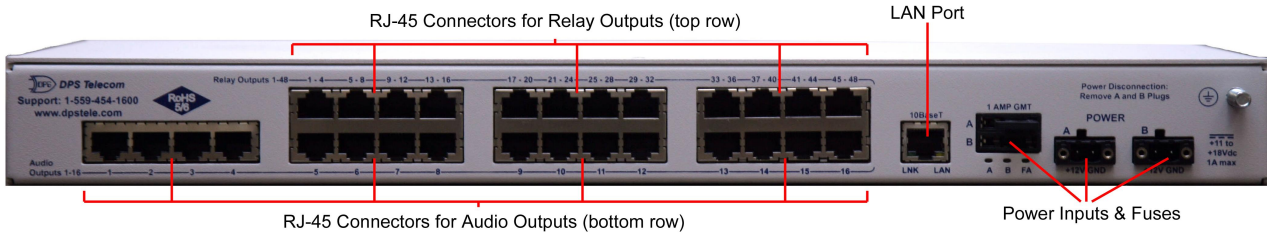


**Fig. 4.2**



**Fig. 4.3**

## 5 Trap 48 RA Back Panel



**Fig 5.1** Trap 48 RA back panel connections

### 5.1 Power Connection


The Trap 48 RA is powered by two screw-locking RIA power connectors.



**Fig. 5.2** The Trap48 RA's power inputs

**Note:** Always use safe power practices when making power connections. Be sure to remove fuses from the fuse distribution panel, as well as the back of the unit, before making your power connections.


**To connect the unit to a power supply:**

1. Use the grounding lug to connect the unit to earth ground. The grounding lug is next to the symbol .
2. Insert the eyelet of the earth ground cable between the two bolts on the grounding lug (Ground cable not included).
3. Insert a battery ground into the power connector plug's right terminal and tighten the screw.
4. Insert a battery lead to the plug's left terminal and tighten its screw.
5. Insert fuse into the fuse distribution panel.
6. Check the power status LED for polarity. (eg. Green = Good, Off = Bad)
7. Measure voltage. Connect the black cable onto the ground connector of your DVM and red cable onto the other connector of your DVM. The voltmeter should read between +12VDC and +18VDC.

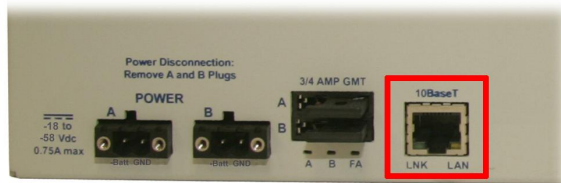
**Note:** The voltage range will depend on build and power input source. If you experience any issues with powering your unit, contact DPS Telecom technical support at 559-454-1600 or support@dpstele.com

8. Insert the local fuse into the power fuse slot. The power plug can be inserted into the power connector only one way to ensure the correct polarity.

**Note:** The negative voltage terminal is on the left and the GND terminal is on the right.

9. Verify that the  LED is lit. To confirm that power is correctly connected, the front panel status LED will flash RED and GREEN, indicating that the firmware is booting up.

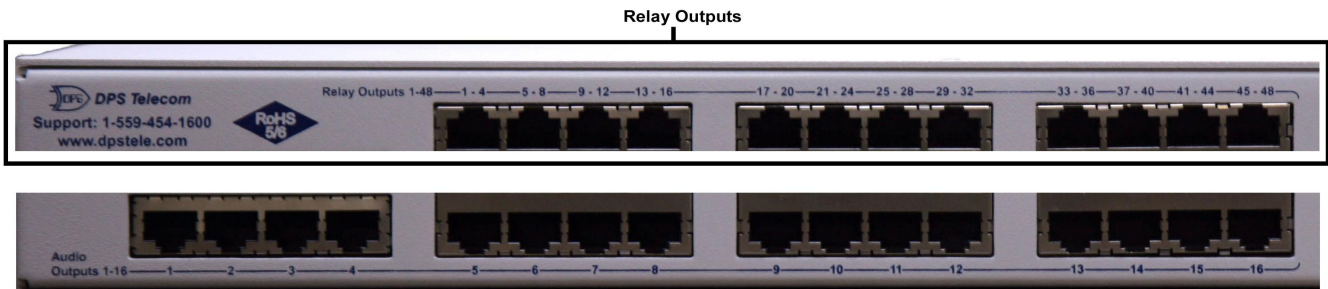
## 5.2 LAN Connection



*Fig. 5.3 LAN Port*

To connect the Trap 48 RA to the LAN, insert a standard RJ45 Ethernet cable into the 10BaseT Ethernet port on the back of the unit. If the LAN connection is OK, the LNK LED will illuminate **SOLID**.

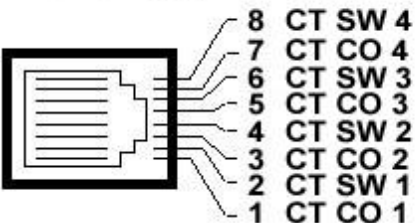
## 5.3 Relay Outputs RJ-45 Connectors



*Fig. 5.4 Relay Outputs*

On the back panel of the Trap 48 RA, the 12 RJ-45 connectors along the top securely terminate the relay outputs. See pinouts below:

### RJ-45 Relay Connection Pinout



Control Relays 1-16			
RLY 1-4	Pin #	RLY 9-12	Pin #
CT 1 CO	1	CT 9 CO	1
CT 1 SW	2	CT 9 SW	2
CT 2 CO	3	CT 10 CO	3
CT 2 SW	4	CT 10 SW	4
CT 3 CO	5	CT 11 CO	5
CT 3 SW	6	CT 11 SW	6
CT 4 CO	7	CT 12 CO	7
CT 4 SW	8	CT 12 SW	8
RLY 5-8	Pin #	RLY 13-16	Pin #
CT 5 CO	1	CT 13 CO	1
CT 5 SW	2	CT 13 SW	2
CT 6 CO	3	CT 14 CO	3
CT 6 SW	4	CT 14 SW	4
CT 7 CO	5	CT 15 CO	5
CT 7 SW	6	CT 15 SW	6
CT 8 CO	7	CT 16 CO	7
CT 8 SW	8	CT 16 SW	8

Control Relays 17-32			
RLY 17-20	Pin #	RLY 25-28	Pin #
CT 17 CO	1	CT 25 CO	1
CT 17 SW	2	CT 25 SW	2
CT 18 CO	3	CT 26 CO	3
CT 18 SW	4	CT 26 SW	4
CT 19 CO	5	CT 27 CO	5
CT 19 SW	6	CT 27 SW	6
CT 20 CO	7	CT 28 CO	7
CT 20 SW	8	CT 28 SW	8
RLY 21-24	Pin #	RLY 29-32	Pin #
CT 21 CO	1	CT 29 CO	1
CT 21 SW	2	CT 29 SW	2
CT 22 CO	3	CT 30 CO	3
CT 22 SW	4	CT 30 SW	4
CT 23 CO	5	CT 31 CO	5
CT 23 SW	6	CT 31 SW	6
CT 24 CO	7	CT 32 CO	7
CT 24 SW	8	CT 32 SW	8

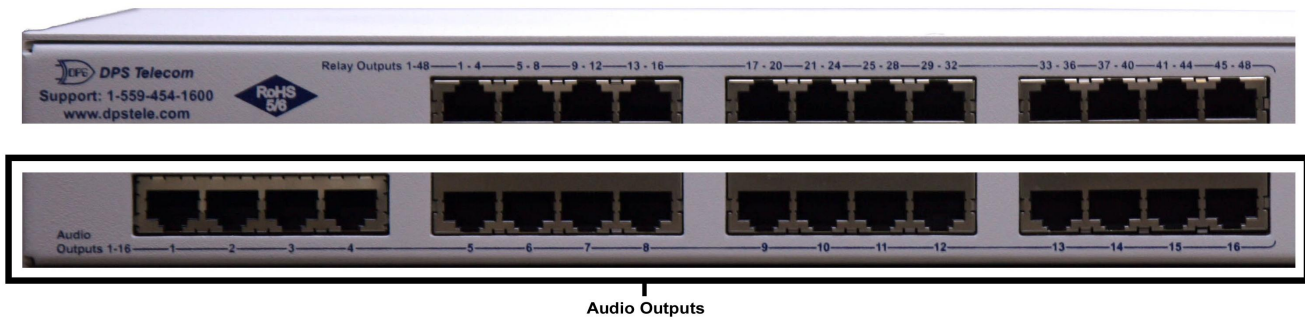
Control Relays 33-48			
RLY 33-36	Pin #	RLY 41-44	Pin #
CT 33 CO	1	CT 41 CO	1
CT 33 SW	2	CT 41 SW	2
CT 34 CO	3	CT 42 CO	3
CT 34 SW	4	CT 42 SW	4
CT 35 CO	5	CT 43 CO	5
CT 35 SW	6	CT 43 SW	6
CT 36 CO	7	CT 44 CO	7
CT 36 SW	8	CT 44 SW	8
RLY 37-40	Pin #	RLY 45-48	Pin #
CT 37 CO	1	CT 45 CO	1
CT 37 SW	2	CT 45 SW	2
CT 38 CO	3	CT 46 CO	3
CT 38 SW	4	CT 46 SW	4
CT 39 CO	5	CT 47 CO	5
CT 39 SW	6	CT 47 SW	6
CT 40 CO	7	CT 48 CO	7
CT 40 SW	8	CT 48 SW	8



**Fig 5.5 Jumpers**

The build option determines if jumpers are present. If they are not, the unit will be hand wired for either N/O if N/C on all relays. Check your product number description for your device's configuration.

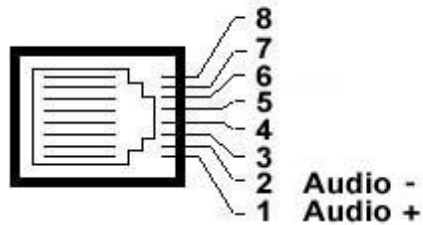
## 5.4 Audio Output Connectors



**Fig. 5.6** Audio Outputs

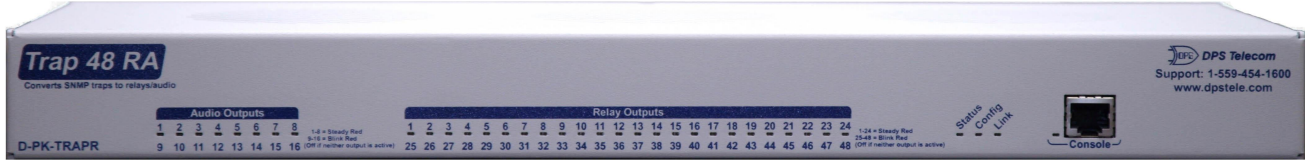
On the back panel of the Trap 48 RA, the 16 RJ-45 connectors along the bottom securely terminate the audio outputs. See pinout below:

### RJ-45 Audio Output Pinout



**Note:** Only pins 1 & 2 are used for the audio outputs' RJ-45 connections.

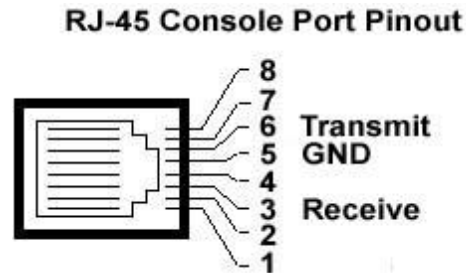
## 6 Trap 48 RA Front Panel



*Fig. 6.1 Trap 48 RA front panel*

### 6.1 RJ-45 Console Port

Use the front-panel RJ-45 console port to connect the Trap 48 RA to a PC for onsite unit configuration. To connect via the RJ-45 console port, use the included DB9 to RJ-45 cable. **Note:** The console port is RS232.



*Fig 6.2 RJ-45 Pinouts (Console Port Only)*

## 7 Quick Start: How to Connect to the Trap 48 RA

Most Trap 48 RA users find it easiest to give the unit an IP address, subnet and gateway through the front serial console port (TTY interface) to start. Once these settings are saved and you reboot the unit, you can access it over LAN to do the rest of your databasing via the Web Browser interface.

**Alternative option:** You can skip the TTY interface by using a LAN crossover cable directly from your PC to the Trap 48 RA and access its Web Browser. See the "...via LAN" section of this chapter.

### 7.1 ...via RJ-45 Console Port (using TTY Interface)



*Fig. 7.1 Trap 48 RA Console Port*

The simplest way to connect to the Trap 48 RA is over a physical cable connection between your PC's COM port and the Trap 48 RA's console port.

#### Select the following COM port options:

- Bits per second: **9600**
- Data bits: **8**
- Parity: **None**
- Stop bits: **1**
- Flow control: **None**

When a connection is established (sometimes accompanied by receipt of a hex byte), press Enter to activate the configuration menu.

The default username is "**admin**" and the default password is "**dpstelecom**".

You can perform basic configuration via the console port — but if you like, you can connect via the console port just to configure the Trap 48 RA's Private LAN IP address, and then do the rest of your configuration via a LAN connection.



## 7.2 ...via LAN (First Time Connection to a Unit at Factory Defaults)



*Fig 7.2 Connection through Ethernet port*

To connect to the Trap 48 RA via LAN, all you need is the unit's IP address (Default IP address is 192.168.1.100).

If you **DON'T** have LAN, but **DO** have physical access to the Trap 48 RA, connect using a LAN crossover cable. **NOTE:** Newer PCs should be able to use a standard straight-through LAN cable and handle the crossover for you. To do this, you will temporarily change your PC's IP address and subnet mask to match the Trap 48 RA's factory default IP settings. Follow these steps:

1. Get a LAN crossover cable and plug it directly into the Trap 48 RA's LAN port.
2. Look up your PC's current IP address and subnet mask, and write this information down.
3. Reset your PC's IP address to **192.168.1.200**. Contact your IT department if you are unsure how to do this.
4. Reset your PC's subnet mask to **255.255.0.0**. You may have to reboot your PC to apply your changes.
5. Once the IP address and subnet mask of your computer coincide with the unit, you can access the Trap 48 RA via a Telnet session or via Web browser by using the unit's default IP address of **192.168.1.100**.
6. Provision the Trap 48 RA with the appropriate information, then **change your computer's IP address and subnet mask back to their original settings**.

**Now you're ready** to do the rest of your configuration via LAN. Plug your Trap 48 RA into your LAN and see the "Logging On to the Trap 48 RA" section to continue databasing using the Web Browser.

## 8 TTY Interface

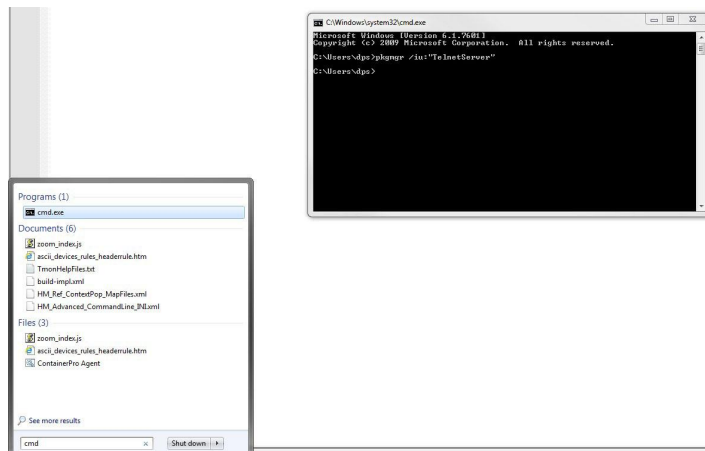
The TTY interface is the Trap 48 RA's built-in interface for basic configuration. From the TTY interface, you can:

- Provisioning the IPA, subnet, and gateway
- Debug and troubleshoot
- Set unit back to factory defaults
- Ping other devices on the network

**Note:** For more advanced configuration tools, please use the Web Browser Interface.

For Telnet, connect to the IP address at port 2002 to access the configuration menus after initial LAN/WAN setup. **Telnet sessions are established at port 2002, not the standard Telnet port** as an added security measure.

If you're using Windows 7, then you'll need to install telnet before you can use the TTY interface. To install telnet, open up your command line (type "cmd" into the search bar in the **Start Menu**). Select **cmd.exe** to run the command line.



From the command line, type in **pkgmgr /iu:"TelnetServer"** then press **enter**. When the command prompt appears again, the installation is complete.

### Menu Shortcut Keys

The letters before or enclosed in parentheses () are menu shortcut keys. Press the shortcut key to access that option. Pressing the ESC key will always bring you back to the previous level. Entries are not case sensitive.

## 9 Trap 48 RA Web Browser

The screenshot shows the web browser interface for the Trap 48 RA G2. The interface is divided into a left sidebar menu and a main content area. The sidebar menu includes: Monitor (blue), Provisioning (green), System (green), Ethernet (green), Notifications (green), Variable Bindings (green), Controls (green), Alarms (green), Ping Targets (green), Date and Time (green), Timers (green), Load Audio Files (green), and Reboot (red). The main content area is titled 'Trap 48 RA G2' and contains several configuration sections:

- System Settings**: Includes Global System Settings with fields for Name (Trap 48 RA G2), Location (Fresno, CA), Contact (559-454-1600), Features (FFBA-15-DCSC), "From" E-mail address (traprelay64@dpstele.com), User (admin), and Password (masked).
- SNMP Settings**: Includes Listening Port (162), Get Community (dps), Set Community (dps), and Inbound Trap Community (dps).
- DCP Responder Settings**: Includes DCP Unit ID (1), Listen DCP over LAN (radio button selected), DCP LAN (2001), and UDP (selected).
- System Controls**: Includes Initialize Configuration (Initialize button), Backup Configuration (config bin, Save button), and Restore Configuration (Upload button).

At the bottom of the main content area, there are 'Reset' and 'Save' buttons.

The Trap 48 RA features a built-in Web Browser Interface that allows you to manage outputs and configure the unit through the Internet or your Intranet. You can quickly set up descriptions, view status, issue commands, configure notification information, and more using most commonly used browsers.

### Trap48 RA G2

The Trap48 RA G2 is a software update that allows your Trap48 RA G1 to have audio via radio functionality.

If you have the Trap48 RA G2 firmware update, you will notice a note in some sections that will specify any differences between the G1 and G2 interfaces.

To learn more about the Trap48 RA G2 update, call DPS at 1(559)454-1600 for more information or to receive a free quote.

### 9.1 Logging on to the Trap 48 RA

For Web Interface functionality, the unit must first be configured with some basic network addresses. If this has not been done yet, refer to the section "Quick Start: How to Connect to the Trap 48 RA" for instructions on initial configuration.

1. To connect to the Trap 48 RA from your Web browser, enter its IP address in the address bar of your web browser. It may be helpful to bookmark the logon page to avoid entering this each time.
2. After connecting to the unit's IP address, enter your login information and click OK. **NOTE:** The factory default username is "**admin**" and the password is "**dpstelecom**".



**Best Practice:** DPS Telecom suggests that you change your password before configuring your unit as seen in section 9.1.1 Changing the Default Password.

3. In the left pane, you will see the **Monitor** menu (blue) and **Provision** menu (green) The Monitor menu links are used to view the current status of alarms. The Provision menu is used to change the unit's configuration settings. All the software configuration will occur in the **Provision** menu. The following sections provide detailed information regarding these functions.

## 9.1.1 Changing the Default Password

The password can be configured from the **Provision > System** screen. The minimum password length is four characters; however, DPS recommends setting the minimum password length to at least five characters.

Use the following steps to change the logon password:

1. From the **Provision** menu select **System**.
2. Enter the new user name in the **User** field.
3. Enter the new password in the **Password** field.
4. Click the **Save** button.

System Settings	
<b>Global System Settings</b>	
Name	Trap 48 RA G2
Location	Fresno, CA
Contact	559-454-1600
Features	FFBA-15-0C5C
"From" E-mail address	traprelay64@dpstele.com
User	admin
Password	.....
<b>SNMP Settings</b>	
Listening Port	162
Get Community	dps
Set Community	dps
Inbound Trap Community	dps
<b>DCP Responder Settings</b> <a href="#">Display Mapping</a>	
DCP Unit ID	1 DCPx ▼
<input type="radio"/> Listen DCP over LAN <input checked="" type="radio"/> Disable Listening	
DCP LAN	2001 UDP ▼
<b>System Controls</b>	
Initialize Configuration	Initialize
Backup Configuration	config.bin Save
Restore Configuration	<a href="#">Upload</a>
Reset Save	

*Fig. 9.1 - Global System Settings section of the Provisioning > System menu*

## 10 Trap 48 RA - Quick Turn Up

The next section of this manual will walk you through one of the Trap 48 RA's most common procedures. You will learn how to configure your inbound traps for an audio output - all using the Web browser. For details on entering your settings into each Web browser menu, go to section 11 "Provisioning Menu Field Descriptions."

### 10.1 How to Configure Trap Parsers for an Output

This section is for the G1 version of the Trap48 RA. If you have the Trap48 RA G2, refer to the next section of this user manual for instructions.

1. Click on the **System** button in the **Provisioning** menu and enter a valid community name for SNMP TRAP requests in the "**Inbound Trap Community**" field. Be sure to **Save** your settings.

System Settings	
<b>Global System Settings</b>	
Name	Trap 48 RA G2
Location	Fresno, CA
Contact	559-454-1600
Features	FFBA-15-0C5C
"From" E-mail address	traprelay64@dpstele.com
User	admin
Password	*****
<b>SNMP Settings</b>	
Listening Port	162
Get Community	dps
Set Community	dps
Inbound Trap Community	dps
<b>DCP Responder Settings</b> <a href="#">Display Mapping</a>	
DCP Unit ID	1 DCPx ▼
<input type="radio"/> Listen DCP over LAN <input checked="" type="radio"/> Disable Listening	
DCP LAN	2001 UDP ▼
<b>System Controls</b>	
Initialize Configuration	<input type="button" value="Initialize"/>
Backup Configuration	config.bin <input type="button" value="Save"/>
Restore Configuration	<a href="#">Upload</a>
<input type="button" value="Reset"/> <input type="button" value="Save"/>	

*Fig. 10.1 - "Inbound Trap Community" under SNMP Settings in the Provisioning > System menu.*

2. Next, navigate to the **Provisioning > Audio** menu.

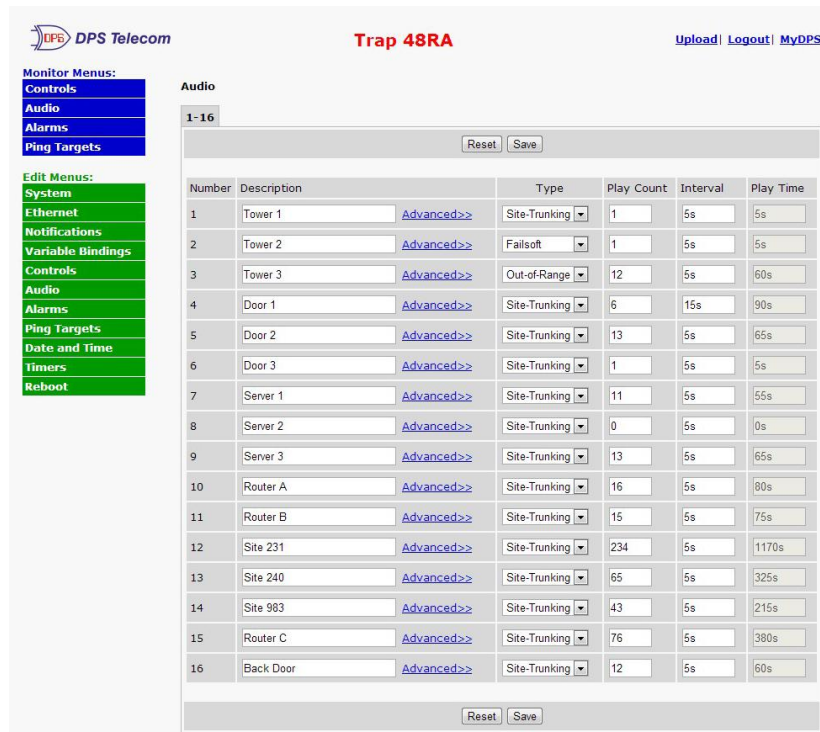


Fig. 10.2 - The Provisioning > Audio menu.

3. Click on the **Advanced<<** tab next to your corresponding output.

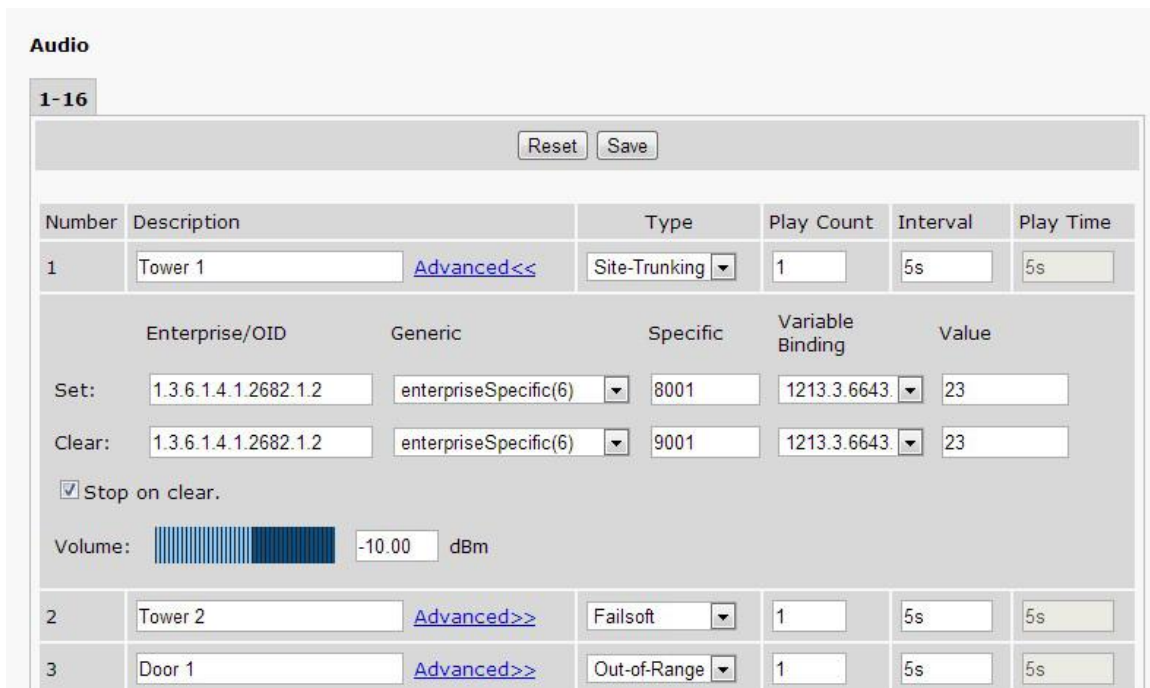


Fig. 10.3 - The Advanced tab under Provisioning > Audio

4. Enter the **Enterprise/OID** that matches the Object Identifier of your SNMP device, and select "enterpriseSpecific(6)" from the **Generic** dropdown menu.
5. If using SNMP version 1, make sure that the **Specific** matches the received Specific in your SNMP device's TRAP.
6. For inputs that are not Enterprise-specific, the **Specific** needs to be set to 0 and another **Generic** should be selected.
7. If necessary, configure a **Variable Binding**. For more information, see **Section 10.8, Variable Bindings**. If using a variable binding, make sure **Value** matches the received TRAP variable binding value.
8. Specify the **Type** of sound, **Play Count**, and **Interval**.
9. Scroll to either the top or bottom of the interface window, and click **Save**.

**Note:** If **Stop on clear** is checked, the audio output will stop when it receives the specified TRAP. This option is left unchecked by default.

## 10.2 G2: How to Configure Trap Parsers for an Output

This section is for the G2 version of the Trap48 RA. If you have the Trap48 RA G1, refer to the previous section of this user manual for instructions.

1. Navigate to the *Provisioning > Load Audio Files* menu. Upload the audio file to be played to one of the 8 available slots.

**NOTE:** The input audio file must be in WAVE format, and must be 12000 Hz u-law encoded.

Load Audio		
Number	Current File	New File
1	<a href="#">TRAP_RELAY_FILE.WAV</a>	Choose File No file chosen Load
2	<a href="#">ileNum</a>	Choose File No file chosen Load
3	<a href="#">ileNum</a>	Choose File No file chosen Load
4	<a href="#">ileNum</a>	Choose File No file chosen Load
5	<a href="#">ileNum</a>	Choose File No file chosen Load
6	not loaded	Choose File No file chosen Load
7	not loaded	Choose File No file chosen Load
8	<a href="#">TRAP_RELAY_FILE2.WAV</a>	Choose File No file chosen Load

2. Click on the *Provisioning > Notifications* menu. Begin the setup by clicking on the number next to the



desired notification.

Notifications					
No.	Stat.	Type	Server	Time Window 1	Time Window 2
<a href="#">1</a>	OFF	Audio		Sun,Mon,Tue,Wed,Thu,Fri,Sat,Any Time	Sun,Mon,Tue,Wed,Thu,Fri,Sat,Any Time
<a href="#">2</a>	OFF	SNMP	126.10.218.85	Sun,Mon,Tue,Wed,Thu,Fri,Sat,Any Time	Sun,Mon,Tue,Wed,Thu,Fri,Sat,Any Time
<a href="#">3</a>	OFF	Audio		Sun,Mon,Tue,Wed,Thu,Fri,Sat,Any Time	Sun,Mon,Tue,Wed,Thu,Fri,Sat,Any Time
<a href="#">4</a>	OFF	Audio		Sun,Mon,Tue,Wed,Thu,Fri,Sat,Any Time	Sun,Mon,Tue,Wed,Thu,Fri,Sat,Any Time
<a href="#">5</a>	OFF	Email		Sun,Mon,Tue,Wed,Thu,Fri,Sat,Any Time	Sun,Mon,Tue,Wed,Thu,Fri,Sat,Any Time
<a href="#">6</a>	OFF	Email		Sun,Mon,Tue,Wed,Thu,Fri,Sat,Any Time	Sun,Mon,Tue,Wed,Thu,Fri,Sat,Any Time
<a href="#">7</a>	OFF	Email		Sun,Mon,Tue,Wed,Thu,Fri,Sat,Any Time	Sun,Mon,Tue,Wed,Thu,Fri,Sat,Any Time
<a href="#">8</a>	OFF	Email		Sun,Mon,Tue,Wed,Thu,Fri,Sat,Any Time	Sun,Mon,Tue,Wed,Thu,Fri,Sat,Any Time

- At the Notification Setting screen, use the drop-down menu to select whether the audio notification should be enabled for alarm, clear, or both, and select the Audio button. Click Next to continue.

**Notification 3**

**Notification Setting**

Notification Disabled ▾

Send Email  
 Send SNMP  
 Audio

Next >    Cancel

- At the Audio Notification screen, choose the audio output ports you want to send this notification to. From the Audio File drop down, select the audio file uploaded in step 1. Specify the number of times to repeat the audio notification and the delay between each playback using the Repeat Count and Repeat Delay fields. Click Next to continue.

**Notification 3 (Audio)**

**Audio Notification**

<b>Audio Output port (1-16)</b>	1 2 3 4 5 6 7 8 9 10 11 12 13 14 15 16
	<input checked="" type="checkbox"/> <input checked="" type="checkbox"/> <input checked="" type="checkbox"/> <input checked="" type="checkbox"/> <input checked="" type="checkbox"/> <input checked="" type="checkbox"/> <input checked="" type="checkbox"/> <input checked="" type="checkbox"/> <input checked="" type="checkbox"/> <input checked="" type="checkbox"/> <input checked="" type="checkbox"/> <input checked="" type="checkbox"/> <input checked="" type="checkbox"/> <input checked="" type="checkbox"/> <input checked="" type="checkbox"/> <input checked="" type="checkbox"/>
<b>Audio File</b>	Use 'Load Audio Files' menu to manage your files. Audio file 1 (TRAP_RELAY_FILE.WAV) ▾
<b>Repeat Count (0-15)</b>	0
<b>Repeat Delay (0s-2m)</b>	1s

< Back    Next >    Cancel



5. At the Schedule screen, select the exact days and times you want to receive audio notifications. Click Test to test the audio notification (see next step), or click *Finish*.

**Notification 3 (Schedule)**

No.	Sun	Mon	Tue	Wed	Thu	Fri	Sat	Notification Time					
1	<input checked="" type="checkbox"/>	<input checked="" type="checkbox"/>	<input checked="" type="checkbox"/>	<input checked="" type="checkbox"/>	<input checked="" type="checkbox"/>	<input checked="" type="checkbox"/>	<input checked="" type="checkbox"/>	<input type="radio"/> Any Time	<input type="radio"/> 12 h 0 min AM	to	<input type="radio"/> 11 h 59 min PM	<input type="radio"/>	<input type="radio"/>
2	<input checked="" type="checkbox"/>	<input checked="" type="checkbox"/>	<input checked="" type="checkbox"/>	<input checked="" type="checkbox"/>	<input checked="" type="checkbox"/>	<input checked="" type="checkbox"/>	<input checked="" type="checkbox"/>	<input type="radio"/> Any Time	<input type="radio"/> 12 h 0 min AM	to	<input type="radio"/> 11 h 59 min PM	<input type="radio"/>	<input type="radio"/>

< Back   Finish   Test   Cancel

6. If you chose to test the audio notification, a popup will appear. Click OK to send a test audio notification. Confirm that all the settings are correct by checking the audio output using a speaker connected to the specified Audio Output port.
7. Next navigate to **Provisioning > Controls** and assign this audio notification to a desired control.
8. Click on *Advanced* << next to the control.

**Controls**

1-24   **25-48**

Reset   Save

Number	Description	Invert Energized State	Echo Ping	Notifications															
1	site down1 <a href="#">Advanced&lt;&lt;</a>	<input type="checkbox"/>	<input type="checkbox"/>	<input type="checkbox"/> <input checked="" type="checkbox"/> <input type="checkbox"/> <input type="checkbox"/> <input type="checkbox"/> <input type="checkbox"/> <input type="checkbox"/>															
<table border="0"> <tr> <td>Enterprise/OID</td> <td>Generic</td> <td>Specific</td> <td>Variable Binding</td> <td>Value Contains</td> </tr> <tr> <td>Set: 1.3.6.1.4.1.2682.1.2</td> <td>enterpriseSpecific(6)</td> <td>8001</td> <td>None</td> <td></td> </tr> <tr> <td>Clear: 1.3.6.1.4.1.2682.1.2</td> <td>enterpriseSpecific(6)</td> <td>9001</td> <td>None</td> <td></td> </tr> </table>					Enterprise/OID	Generic	Specific	Variable Binding	Value Contains	Set: 1.3.6.1.4.1.2682.1.2	enterpriseSpecific(6)	8001	None		Clear: 1.3.6.1.4.1.2682.1.2	enterpriseSpecific(6)	9001	None	
Enterprise/OID	Generic	Specific	Variable Binding	Value Contains															
Set: 1.3.6.1.4.1.2682.1.2	enterpriseSpecific(6)	8001	None																
Clear: 1.3.6.1.4.1.2682.1.2	enterpriseSpecific(6)	9001	None																
2	site down2 <a href="#">Advanced&gt;&gt;</a>	<input type="checkbox"/>	<input type="checkbox"/>	<input type="checkbox"/> <input checked="" type="checkbox"/> <input type="checkbox"/> <input type="checkbox"/> <input type="checkbox"/> <input type="checkbox"/> <input type="checkbox"/>															
3	site down3 <a href="#">Advanced&gt;&gt;</a>	<input type="checkbox"/>	<input type="checkbox"/>	<input type="checkbox"/> <input checked="" type="checkbox"/> <input type="checkbox"/> <input type="checkbox"/> <input type="checkbox"/> <input type="checkbox"/> <input type="checkbox"/>															
4	site down4 <a href="#">Advanced&gt;&gt;</a>	<input type="checkbox"/>	<input type="checkbox"/>	<input type="checkbox"/> <input checked="" type="checkbox"/> <input type="checkbox"/> <input type="checkbox"/> <input type="checkbox"/> <input type="checkbox"/> <input type="checkbox"/>															

9. Enter the Enterprise/OID that matches the Object Identifier of your SNMP device, and select "enterpriseSpecific(6)" from the Generic dropdown menu. If using SNMP version 1, make sure that the Specific matches the received Specific in your SNMP devices' TRAP. For inputs that are not Enterprise-specific, the Specific needs to be set to 0 and another Generic should be selected. If necessary, configure a Variable Binding. For more information, see the section regarding Variable Bindings. If using a variable binding, make sure Value matches the received TRAP variable binding value.

## 10.3 Useful Tools

### iReasoning

iReasoning's MIB browser is a useful tool for managing SNMP enabled network devices and applications. The MIB browser allows you to send, receive, and process SNMP traps according to its rule engine. The iReasoning MIB browser runs on Windows, Mac OS X, Linux and other UNIX platforms, and can be a valuable tool to use along with your Trap 48 RA device.

<http://www.ireasoning.com/>

### Wireshark

Wireshark is a network protocol analyzer that lets you capture and interactively browse the traffic running on a computer network. Used in conjunction with your Trap 48 RA, Wireshark can provides useful visibility, allowing you to monitor and troubleshoot your network activity.

<http://www.wireshark.org/>


# 11 Provisioning Menu Field Descriptions


## 11.1 System

From the **Provisioning > System** menu, you will configure and edit the global system, T/Mon and control settings for the Trap 48 RA.

System Settings	
<b>Global System Settings</b>	
Name	Trap 48 RA G2
Location	Fresno, CA
Contact	559-454-1600
Features	FFBA-15-0C5C
"From" E-mail address	traprelay64@dpstele.com
User	admin
Password	.....
<b>SNMP Settings</b>	
Listening Port	162
Get Community	dps
Set Community	dps
Inbound Trap Community	dps
<b>DCP Responder Settings</b> <a href="#">Display Mapping</a>	
DCP Unit ID	1 DCPx ▼
<input type="radio"/> Listen DCP over LAN <input checked="" type="radio"/> Disable Listening	
DCP LAN	2001 UDP ▼
<b>System Controls</b>	
Initialize Configuration	<input type="button" value="Initialize"/>
Backup Configuration	config.bin <input type="button" value="Save"/>
Restore Configuration	<a href="#">Upload</a>
<input type="button" value="Reset"/> <input type="button" value="Save"/>	

*The Provisioning > System menu*

Global System Settings	
Name	A name for this Trap 48 RA. (Optional field)
Location	The location of this Trap 48 RA. (Optional field)
Contact	Contact telephone number for the person responsible for this Trap 48 RA. (Optional field)
"From" Email Address	A valid email address used by the Trap 48 RA for sending email alarm notifications.
User	Used to change the username for logging into the unit.
Password	Used to change the password for logging into the unit (case-sensitive).
SNMP Settings	
Listening Port	Enter the port number which traps must be sent to.
Get Community	Community name for SNMP requests. (case-sensitive).
Set Community	Community name for SNMP SET requests. (case-sensitive).
Inbound Trap Community	Community name for SNMP TRAP requests. (case-sensitive).
DCP Responder Settings (For use with T/Mon Master Station)	
DCP Unit ID	User-definable ID number for this Trap 48 RA (DCP Address).
Listen DCP	Choose to listen DCP over LAN. May also be disabled.
DCP LAN	Enter the DCP port for this Trap 48 RA (UDP/TCP port).
System Controls	
Initialize Configuration	Used to restore all factory default settings to the Trap 48 RA. Do not initialize the non-volatile RAM (NVRAM) unless you want to re-enter all of your configuration settings again.
Backup Configuration	 Save the Trap 48 RA's configuration as a .BIN file to your local PC.
Restore Configuration	Click the "Upload" link and select a .BIN configuration file that you saved previously to your local PC. This will restore the saved configuration.

 **Best Practice:** Always make a copy of your Trap 48 RA's configurations

## 11.2 Ethernet

The **Provisioning > Ethernet** menu allows you to define and configure Ethernet settings.

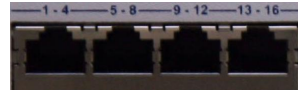
Ethernet Settings	
MAC Address :	00.10.81.00.71.6F
Host Name :	<input type="text"/> ( )
Enable DHCP :	<input type="checkbox"/>
Unit IP :	<input type="text" value="126.10.218.156"/> (126.10.218.156)
Subnet Mask :	<input type="text" value="255.255.0.0"/> (255.255.0.0)
Gateway :	<input type="text" value="126.10.220.254"/> (126.10.220.254)
DNS Server 1 :	<input type="text" value="255.255.255.255"/> (255.255.255.255)
DNS Server 2 :	<input type="text" value="255.255.255.255"/> (255.255.255.255)
<input type="button" value="Reset"/> <input type="button" value="Save"/>	

*The Provisioning > Ethernet menu*

<b>Ethernet Settings</b>	
<b>MAC Address</b>	Hardware address of the Trap 48 RA. (Not editable - For reference only.)
<b>Host Name</b>	Used only for local web browsing. Example: If you don't want to remember this Trap 48 RA's IP address, you can type in a name in this field, such as Trap 48 RA. Once you save and reboot the unit, you can now browse to it locally by simply typing in "Trap 48 RA" in the address bar (no "https://" needed).
<b>Enable DHCP</b>	Used to turn on Dynamic Host Connection Protocol. NOT recommended, because the unit is assigned an IP address from your DHCP server. The IP you've already assigned to the unit becomes inactive. Using DHCP means the unit will NOT operate in a T/Mon environment.
<b>Unit IP</b>	IP address of the Trap 48 RA.
<b>Subnet Mask</b>	A road sign to the Trap 48 RA, telling it whether your packets should stay on your local network or be forwarded somewhere else on a wide-area network.
<b>Gateway</b>	An important parameter if you are connected to a wide-area network. It tells the Trap 48 RA which machine is the gateway out of your local network. Set to 255.255.255.255 if not using. Contact your network administrator for this info.
<b>DNS Server 1</b>	Primary IP address of the domain name server. Set to 255.255.255.255 if not using.
<b>DNS Server 2</b>	Secondary IP address of the domain name server. Set to 255.255.255.255 if not using.

## 11.3 Controls

A Trap 48 RA relay can be configured in the **Provisioning > Controls** menu. You can enter your own description for this relay and designate it to a notification device(s)



Closeup of Relay Inputs 1-16

Controls

1-24 **25-48**

Reset Save

Number	Description	Invert Energized State	Echo Ping	Notifications	
1	site down1 <a href="#">Advanced&lt;&lt;</a>	<input type="checkbox"/>	<input type="checkbox"/>	<input type="checkbox"/> <input checked="" type="checkbox"/> <input type="checkbox"/> <input type="checkbox"/> <input type="checkbox"/> <input type="checkbox"/> <input type="checkbox"/> <input type="checkbox"/>	
Enterprise/OID		Generic	Specific	Variable Binding	Value Contains
Set:	1.3.6.1.4.1.2682.1.2	enterpriseSpecific(6) ▼	8001	None ▼	
Clear:	1.3.6.1.4.1.2682.1.2	enterpriseSpecific(6) ▼	9001	None ▼	
2	site down2 <a href="#">Advanced&gt;&gt;</a>	<input type="checkbox"/>	<input type="checkbox"/>	<input type="checkbox"/> <input checked="" type="checkbox"/> <input type="checkbox"/> <input type="checkbox"/> <input type="checkbox"/> <input type="checkbox"/> <input type="checkbox"/> <input type="checkbox"/>	
3	site down3 <a href="#">Advanced&gt;&gt;</a>	<input type="checkbox"/>	<input type="checkbox"/>	<input type="checkbox"/> <input checked="" type="checkbox"/> <input type="checkbox"/> <input type="checkbox"/> <input type="checkbox"/> <input type="checkbox"/> <input type="checkbox"/> <input type="checkbox"/>	
4	site down4 <a href="#">Advanced&gt;&gt;</a>	<input type="checkbox"/>	<input type="checkbox"/>	<input type="checkbox"/> <input checked="" type="checkbox"/> <input type="checkbox"/> <input type="checkbox"/> <input type="checkbox"/> <input type="checkbox"/> <input type="checkbox"/> <input type="checkbox"/>	

The Provisioning > Controls menu

Provisioning Control Relays	
<b>Description</b>	User-definable description for the Trap 48 RA's control.
<b>Notifications</b>	Check which notification device(s), 1 through 8, you want to send alarm notifications for the control.
<b>Energized State</b>	When the box in the Energize State column is not checked, the relay's normal electrical state is <b>De-energized</b> . Checking this box will set the relay's normal electrical state to <b>Energized</b> .
<b>Echo Ping</b>	Associates the control relay with the ping target of the same ID/Number. When a ping fails, the relay will latch. If the ping is successful, the relay will release. <b>Note:</b> Enabling Echo Ping will prevent the relay from being triggered by trap OIDs.
Advanced	
<b>Set</b>	Enter the Enterprise/OID, Generic Type and Specific Type to operate a relay.
<b>Clear</b>	Enter the Enterprise/OID, Generic Type and Specific Type to release a relay.
<b>Variable Binding</b>	If defined, additional OID (from equipment connected to control relay) to uniquely identify the SNMP trap.
<b>Value</b>	Value of the variable binding. Must be integer or string (when searching for a specific string, the string must be contained within the received trap variable binding value). <b>Note:</b> Using a * in this field is like a "wild card" - any value is accepted.

**Note:** The **Advanced** tab will only appear when "Granular" Trap Processing Mode is selected in the **Provisioning > System** menu. Refer to section 11.6.1 for further detail.

**Note:** If the **Description** is configured in the following manner: \_IP:xxx.xxx.xxx.xxx (where

"xxx.xxx.xxx.xxx" is the desired IP address), the relay will only respond to traps received from the configured IP in the description.

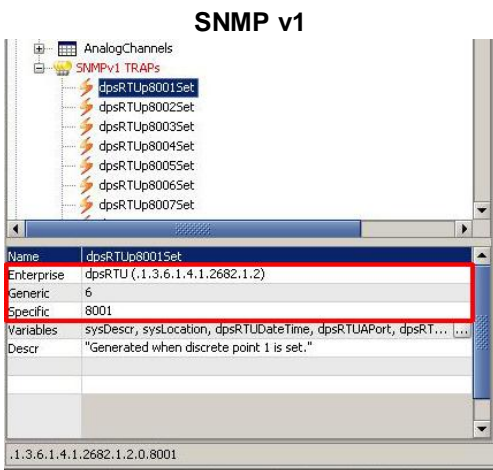
### 11.3.1 Configuring Granular OID

The Trap 48 RA has a granular mode for processing incoming SNMP traps.

#### Granular Mode (for any SNMP device):

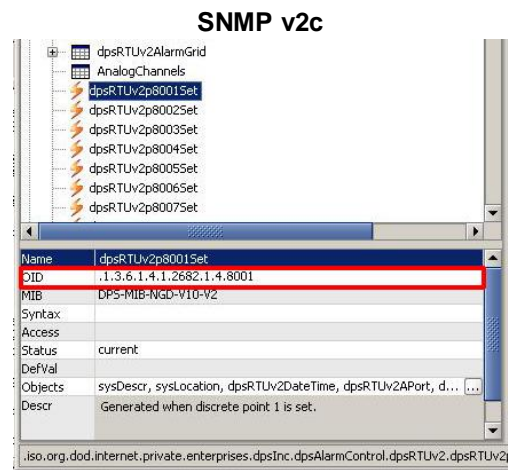
Each Relay will operate or release based on the trap information of an SNMPv1 trap or the OID of an SNMPv2c trap. Granular Mode can be used with any SNMP device. Other modes are only used with specific SNMP device types to provide specialized functionality. The **Advanced>>** button displays options for inputting the Enterprise/OID, Generic, and Specific information for the **Set** and **Clear** trap commands.

### Granular Mode



**Fig. 11.4** - Location of the OID, Generic Type and Specific Type information for SNMP v1

In your MIB Browser (freeware MIB Browser software available for free trial) navigate to the SNMPv1 TRAPS to obtain the Enterprise, Generic Type and Specific Type as seen in the image above. This information is needed for the **Set** and **Clear** properties in the **Advanced** tab.



**Fig. 11.5** - Location of the OID information for SNMP v2c

When using a SNMP v2c TRAP, you only need to configure the TRAP OID. The location of the OID in your MIB Browser can be seen in the image above.

In the image below **Control 1** "Relay 1" is configured using a SNMP v1 trap's Enterprise, Generic Type and Specific Type.

Controls

1-24 **25-48**

Reset Save

Number	Description	Invert Energized State	Echo Ping	Notifications															
1	site down1 <a href="#">Advanced&lt;&lt;</a>	<input type="checkbox"/>	<input type="checkbox"/>	<input type="checkbox"/> <input checked="" type="checkbox"/> <input type="checkbox"/> <input type="checkbox"/> <input type="checkbox"/> <input type="checkbox"/>															
<table border="1"> <thead> <tr> <th>Enterprise/OID</th> <th>Generic</th> <th>Specific</th> <th>Variable Binding</th> <th>Value Contains</th> </tr> </thead> <tbody> <tr> <td>Set: 1.3.6.1.4.1.2682.1.2</td> <td>enterpriseSpecific(6)</td> <td>8001</td> <td>None</td> <td></td> </tr> <tr> <td>Clear: 1.3.6.1.4.1.2682.1.2</td> <td>enterpriseSpecific(6)</td> <td>9001</td> <td>None</td> <td></td> </tr> </tbody> </table>					Enterprise/OID	Generic	Specific	Variable Binding	Value Contains	Set: 1.3.6.1.4.1.2682.1.2	enterpriseSpecific(6)	8001	None		Clear: 1.3.6.1.4.1.2682.1.2	enterpriseSpecific(6)	9001	None	
Enterprise/OID	Generic	Specific	Variable Binding	Value Contains															
Set: 1.3.6.1.4.1.2682.1.2	enterpriseSpecific(6)	8001	None																
Clear: 1.3.6.1.4.1.2682.1.2	enterpriseSpecific(6)	9001	None																
2	site down2 <a href="#">Advanced&gt;&gt;</a>	<input type="checkbox"/>	<input type="checkbox"/>	<input type="checkbox"/> <input checked="" type="checkbox"/> <input type="checkbox"/> <input type="checkbox"/> <input type="checkbox"/> <input type="checkbox"/>															
3	site down3 <a href="#">Advanced&gt;&gt;</a>	<input type="checkbox"/>	<input type="checkbox"/>	<input type="checkbox"/> <input checked="" type="checkbox"/> <input type="checkbox"/> <input type="checkbox"/> <input type="checkbox"/> <input type="checkbox"/>															
4	site down4 <a href="#">Advanced&gt;&gt;</a>	<input type="checkbox"/>	<input type="checkbox"/>	<input type="checkbox"/> <input checked="" type="checkbox"/> <input type="checkbox"/> <input type="checkbox"/> <input type="checkbox"/> <input type="checkbox"/>															

Fig. 11.6

**NOTE:** To use the IP filter feature for the Granular Mode, type "\_IP:xxx.xxx.xxx.xxx " (where "xxx.xxx.xxx.xxx" is the desired IP address) in the description field followed by the IP of the source SNMP trap (example: 192.168.1.1) and only traps from the specified IP address will be processed.

### Invert Energized State

The 'Energized State' checkbox for each Relay may be used to "reverse the polarity" of that relay.

**When the 'Invert Energized State' checkbox IS NOT checked,** the relay will be "normally open." On startup, the relay will be in a released state. When the specified "Set" SNMP trap is received, the relay will latch. When the specified "Clear" SNMP trap is received, the relay will release. This is the commonly used configuration for 'Invert Energized State.'

**When the 'Invert Energized State' checkbox IS checked,** the relay will be "normally closed." On startup, the relay will be in a latched state. When the specified "Set" SNMP trap is received, the relay will release. When the specified "Clear" SNMP trap is received, the relay will latch. This is not a common configuration, but it can be very useful in certain situations.

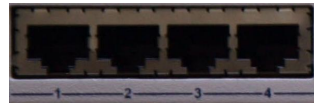
**Invert Energized State has no effect on Notification Devices.** If you configure a Notification Device to trigger on "Set" events and associate it with a Relay, it will always trigger when the specified "Set" SNMP trap is received. The opposite is true for "Clear" Notification Devices when "Clear" SNMP traps are received. Even if you've reversed the latch/release operation of a Relay using Energized State, associated Notification Devices respond to "Set" and "Clear" SNMP traps in the same way. Of course, this distinction is irrelevant for Notification Devices configured to trigger on "Both" event types, which trigger on both "Set" and "Clear".



# 11.4 Audio

**NOTE:** This feature is not present in *Provisioning Mode* of the Trap48 RA G2 web browser.

Configuration for the 16 audio alarms can be done from the **Provisioning > Audio** window.



*Closeup of Audio Inputs 1-4*

**Audio**

1-16

Reset Save

Number	Description	Type	Play Count	Interval	Play Time
1	Server A <a href="#">Advanced&lt;&lt;</a>	Site-Trunking	10	1s	10s

Enterprise/OID    Generic    Specific    Variable Binding    Value

Set: 1.3.6.1.4.1.2682.1.2    enterpriseSpecific(6)    0    1.2.5.\*    1

Clear: 1.3.6.1.4.1.2682.1.2    enterpriseSpecific(6)    9001    None

Stop on clear.

Volume: -11.50 dBm    Test    Stop

Use Trap OIDs     Use Relays

Relays:    Parse

2	<a href="#">Advanced&gt;&gt;</a>	Site-Trunking	1	5s	5s
3	<a href="#">Advanced&gt;&gt;</a>	Site-Trunking	1	5s	5s
4	<a href="#">Advanced&gt;&gt;</a>	Site-Trunking	1	5s	5s

*The Provisioning > Audio interface*

Provisioning Audio	
<b>Number</b>	Audio port number.
<b>Description</b>	User-definable description for the audio alarm.
<b>Type</b>	Type of audio alert: <b>Site-Trunking</b> : Two beeps. <b>Failsoft</b> : Regular beep. <b>Out-of-Range</b> : Constant tone.
<b>Play Count</b>	The number of times the audible alert will be played. Minimum play count value is 0 and maximum play count value is 255. If Play Count is 0, the audio will play indefinitely until a clear condition occurs.
<b>Interval</b>	The amount of time (in seconds) between alerts. Minimum interval value is 1s and maximum interval value is 60s.
<b>Play Time</b>	Display only. The total duration of audible alert.
Advanced>>	
<b>Set</b>	Enter the Enterprise/OID, Generic Type and Specific Type for turning on the audio output.
<b>Clear</b>	Enter the Enterprise/OID, Generic Type and Specific Type for turning off the audio output .
<b>Variable Binding</b>	If defined, additional OID (from equipment connected to control relay) to uniquely identify the SNMP trap.
<b>Value</b>	Value of the variable binding. Must be integer or string (when searching for a specific string, the string must be contained within the received trap variable binding value). <b>Note</b> : Using a * in this field is like a "wild card" - any value is accepted.
<b>Stop on Clear</b>	When checked, stops audible alert upon receiving a clear command.
<b>Volume</b>	Volume slider that controls the volume of the audible alert.
<b>Test</b>	Conducts a test of the current settings of the Audio Alert.
<b>Stop</b>	Stops the test of the Audio Alert.
<b>Use Trap OIDs</b>	Configure the audio port to use SNMP traps.
<b>Use Relays</b>	Configure the audio port to use relays.
<b>Relays</b>	Enter the relay(s) that will trigger the audio. <i>Ex: entering "1-5,7,9-14" would set relays 1 to 5, 7, and 9 to 14 to all trigger audible alert.</i> <b>Note</b> : Each time a listed relay latches, audio will play. Play Count determines the number of times the audio will play for each time a relay latches. A play count of 0 mean the audio will continue to repeat as long as any relay is latched.

## 11.5 System Alarms

**Alarms**

**System**

	Description	Rpt	Notifications
33	Default configuration	<input type="checkbox"/>	<input type="checkbox"/> <input type="checkbox"/> <input type="checkbox"/> <input type="checkbox"/> <input type="checkbox"/> <input type="checkbox"/> <input type="checkbox"/> <input type="checkbox"/> <input type="checkbox"/> <input type="checkbox"/> <input type="checkbox"/> <input type="checkbox"/> <input type="checkbox"/> <input type="checkbox"/> <input type="checkbox"/> <input type="checkbox"/> <input type="checkbox"/> <input type="checkbox"/> <input type="checkbox"/> <input type="checkbox"/> <input type="checkbox"/>
35	MAC address not set	<input type="checkbox"/>	<input type="checkbox"/> <input type="checkbox"/> <input type="checkbox"/> <input type="checkbox"/> <input type="checkbox"/> <input type="checkbox"/> <input type="checkbox"/> <input type="checkbox"/> <input type="checkbox"/> <input type="checkbox"/> <input type="checkbox"/> <input type="checkbox"/> <input type="checkbox"/> <input type="checkbox"/> <input type="checkbox"/> <input type="checkbox"/> <input type="checkbox"/> <input type="checkbox"/> <input type="checkbox"/> <input type="checkbox"/> <input type="checkbox"/>
36	IP address not set	<input type="checkbox"/>	<input type="checkbox"/> <input type="checkbox"/> <input type="checkbox"/> <input type="checkbox"/> <input type="checkbox"/> <input type="checkbox"/> <input type="checkbox"/> <input type="checkbox"/> <input type="checkbox"/> <input type="checkbox"/> <input type="checkbox"/> <input type="checkbox"/> <input type="checkbox"/> <input type="checkbox"/> <input type="checkbox"/> <input type="checkbox"/> <input type="checkbox"/> <input type="checkbox"/> <input type="checkbox"/> <input type="checkbox"/> <input type="checkbox"/>
37	LAN hardware error	<input type="checkbox"/>	<input type="checkbox"/> <input type="checkbox"/> <input type="checkbox"/> <input type="checkbox"/> <input type="checkbox"/> <input type="checkbox"/> <input type="checkbox"/> <input type="checkbox"/> <input type="checkbox"/> <input type="checkbox"/> <input type="checkbox"/> <input type="checkbox"/> <input type="checkbox"/> <input type="checkbox"/> <input type="checkbox"/> <input type="checkbox"/> <input type="checkbox"/> <input type="checkbox"/> <input type="checkbox"/> <input type="checkbox"/> <input type="checkbox"/>
38	SNMP processing error	<input type="checkbox"/>	<input type="checkbox"/> <input type="checkbox"/> <input type="checkbox"/> <input type="checkbox"/> <input type="checkbox"/> <input type="checkbox"/> <input type="checkbox"/> <input type="checkbox"/> <input type="checkbox"/> <input type="checkbox"/> <input type="checkbox"/> <input type="checkbox"/> <input type="checkbox"/> <input type="checkbox"/> <input type="checkbox"/> <input type="checkbox"/> <input type="checkbox"/> <input type="checkbox"/> <input type="checkbox"/> <input type="checkbox"/> <input type="checkbox"/>
39	SNMP community error	<input type="checkbox"/>	<input type="checkbox"/> <input type="checkbox"/> <input type="checkbox"/> <input type="checkbox"/> <input type="checkbox"/> <input type="checkbox"/> <input type="checkbox"/> <input type="checkbox"/> <input type="checkbox"/> <input type="checkbox"/> <input type="checkbox"/> <input type="checkbox"/> <input type="checkbox"/> <input type="checkbox"/> <input type="checkbox"/> <input type="checkbox"/> <input type="checkbox"/> <input type="checkbox"/> <input type="checkbox"/> <input type="checkbox"/> <input type="checkbox"/>

*The Provisioning > System Alarms menu*

Choose the "System" tab on the *Provisioning > System Alarms* menu to view the system alarms. These are "software" alarms that are internally generated by the Trap 48 RA to report various events and problems (ex. "Unit has reset" or "NTP server connection has failed").

Provisioning System Alarms	
<b>(first column)</b>	Alarm point number
<b>Description</b>	Non-editable description for this System (housekeeping) Alarm.
<b>Rpt (Report)</b>	Check this box to choose to report this alarm. Check the box in the green bar (top) to have <u>all</u> System Alarms reported. Leave unchecked to ignore.
<b>Notification devices</b>	Check which notification device(s), 1 through 8, you want to send alarm notifications for that alarm point. Check the box in the green bar (top) to have that notification device send a notification for <u>all</u> the System Alarms.

## 11.6 Ping Targets

Configuration for the 64 ping targets can be done from the *Provisioning > Ping Targets* window.

**Ping Targets**

1-32 **33-64**

Reset Save

ID	Description	IP Address	Notifications
1	Router 1	255.255.255.255	<input type="checkbox"/> <input type="checkbox"/> <input type="checkbox"/> <input type="checkbox"/> <input type="checkbox"/> <input type="checkbox"/> <input type="checkbox"/> <input type="checkbox"/> <input type="checkbox"/> <input type="checkbox"/>
2	Router 2	255.255.255.255	<input type="checkbox"/> <input type="checkbox"/> <input type="checkbox"/> <input type="checkbox"/> <input type="checkbox"/> <input type="checkbox"/> <input type="checkbox"/> <input type="checkbox"/> <input type="checkbox"/> <input type="checkbox"/>
3	Ethernet Switch	255.255.255.255	<input type="checkbox"/> <input type="checkbox"/> <input type="checkbox"/> <input type="checkbox"/> <input type="checkbox"/> <input type="checkbox"/> <input type="checkbox"/> <input type="checkbox"/> <input type="checkbox"/> <input type="checkbox"/>
4	Media Converter	255.255.255.255	<input type="checkbox"/> <input type="checkbox"/> <input type="checkbox"/> <input type="checkbox"/> <input type="checkbox"/> <input type="checkbox"/> <input type="checkbox"/> <input type="checkbox"/> <input type="checkbox"/> <input type="checkbox"/>
5	Server 1	255.255.255.255	<input type="checkbox"/> <input type="checkbox"/> <input type="checkbox"/> <input type="checkbox"/> <input type="checkbox"/> <input type="checkbox"/> <input type="checkbox"/> <input type="checkbox"/> <input type="checkbox"/> <input type="checkbox"/>
6	Server 2	255.255.255.255	<input type="checkbox"/> <input type="checkbox"/> <input type="checkbox"/> <input type="checkbox"/> <input type="checkbox"/> <input type="checkbox"/> <input type="checkbox"/> <input type="checkbox"/> <input type="checkbox"/> <input type="checkbox"/>

*The Provisioning > Ping Targets interface*

Provisioning Ping Targets	
<b>ID</b>	Point number.
<b>Description</b>	User-definable description for the ping target.
<b>IP Address</b>	IP address of the device (the ping target).
<b>Notifications</b>	Check which notification device(s), 1 through 8, you want to send alarm notifications for that ping target.

## 11.7 Notifications

From the initial **Provisioning > Notifications** menu, you may configure any of eight different notifications for your Trap 48 RA's alarms. Click on the number of the notification in the far left column under **No.** to begin configuring notifications.

Notifications					
No.	Stat.	Type	Server	Time Window 1	Time Window 2
<a href="#">1</a>	OFF	Audio		Sun,Mon,Tue,Wed,Thu,Fri,Sat,Any Time	Sun,Mon,Tue,Wed,Thu,Fri,Sat,Any Time
<a href="#">2</a>	OFF	SNMP	126.10.218.85	Sun,Mon,Tue,Wed,Thu,Fri,Sat,Any Time	Sun,Mon,Tue,Wed,Thu,Fri,Sat,Any Time
<a href="#">3</a>	OFF	Audio		Sun,Mon,Tue,Wed,Thu,Fri,Sat,Any Time	Sun,Mon,Tue,Wed,Thu,Fri,Sat,Any Time
<a href="#">4</a>	OFF	Audio		Sun,Mon,Tue,Wed,Thu,Fri,Sat,Any Time	Sun,Mon,Tue,Wed,Thu,Fri,Sat,Any Time
<a href="#">5</a>	OFF	Email		Sun,Mon,Tue,Wed,Thu,Fri,Sat,Any Time	Sun,Mon,Tue,Wed,Thu,Fri,Sat,Any Time
<a href="#">6</a>	OFF	Email		Sun,Mon,Tue,Wed,Thu,Fri,Sat,Any Time	Sun,Mon,Tue,Wed,Thu,Fri,Sat,Any Time
<a href="#">7</a>	OFF	Email		Sun,Mon,Tue,Wed,Thu,Fri,Sat,Any Time	Sun,Mon,Tue,Wed,Thu,Fri,Sat,Any Time
<a href="#">8</a>	OFF	Email		Sun,Mon,Tue,Wed,Thu,Fri,Sat,Any Time	Sun,Mon,Tue,Wed,Thu,Fri,Sat,Any Time

*The Provisioning > Notifications menu*

After clicking on a notification, you will tell the Trap 48 RA what sorts of events you'd like to see notifications and what sort of notification to send.

- In the drop-down box, choose whether you'd like to receive notification for alarms, clears, or both. You may also disable the notification by selecting the appropriate option.
- Next, choose the sort of notification you would like sent when an event occurs. You may choose:
  - **Send Email** to have an email sent when events occur
  - **Send SNMP** to have a trap sent when events occur
  - **Send Audio** to have an audio file played back when events occur
    - *This Feature is only available in the G2 firmware version.*
- Click **Next >** to continue configuring notifications.

**Notification 3**

**Notification Setting**

Notification Disabled ▾

Send Email  
 Send SNMP  
 Audio

Next >    Cancel

*The Notification Setting menu in the G2 firmware. G1 firmware does NOT have Audio.*

## 11.7.1 Notification Settings

### Email Notification Fields

Notification 1 (Email)

Email Notification	
SMTP Server IP or Host Name	<input type="text"/>
Port No. (Usually Use 25)	<input type="text" value="65535"/>
"From" E-mail Address	traprelay64@dpstele.com
"To" E-mail Address	<input type="text"/>

*Provisioning Email Notification Settings*

4a. Enter the appropriate information for email notifications in the fields of the Email Notification screen. Click **Next >** to continue.

Email Notification	
<b>SMTP Server IP or Host Name</b>	The IP address of your email server.
<b>Port Number</b>	The port used by your email server to receive emails, usually set to 25.
<b>"From" E-mail Address</b>	Displays the email address (defined in the Provisioning menu > System) that the Trap 48 RA will send email from. Not editable from this screen.
<b>"To" E-mail Address</b>	The email address of the person responsible for this Trap 48 RA, who will receive email alarm notifications.

### SNMP Outbound Notification Fields

Notification 2 (SNMP)

SNMP Notification	
SNMP Trap Server IP	<input type="text" value="126.10.218.85"/>
Trap Port No. (Usually Use 162)	<input type="text" value="162"/>
Trap Community	<input type="text" value="public"/>

*Provisioning SNMP notification settings*

4b. Enter the appropriate information for SNMP Trap notifications in the fields of the SNMP Notification screen. Click **Next >** to continue.

SNMP Notification	
<b>SNMP Trap Server IP</b>	The SNMP trap manager's IP address.
<b>Trap Port No.</b>	The SNMP port (UDP port) set by the SNMP trap manager to receive traps, usually set to 162.
<b>Trap Community</b>	Community name for SNMP TRAP requests.

### Audio Notification Fields

**NOTE: This notification type is only available in G2 firmware.**

**Notification 3 (Audio)**

**Audio Notification**

<b>Audio Output port (1-16)</b>	1 2 3 4 5 6 7 8 9 10 11 12 13 14 15 16 <input checked="" type="checkbox"/> <input checked="" type="checkbox"/> <input checked="" type="checkbox"/> <input checked="" type="checkbox"/> <input checked="" type="checkbox"/> <input checked="" type="checkbox"/> <input checked="" type="checkbox"/> <input checked="" type="checkbox"/> <input checked="" type="checkbox"/> <input checked="" type="checkbox"/> <input checked="" type="checkbox"/> <input checked="" type="checkbox"/> <input checked="" type="checkbox"/> <input checked="" type="checkbox"/> <input checked="" type="checkbox"/> <input checked="" type="checkbox"/>
<b>Audio File</b>	Use 'Load Audio Files' menu to manage your files. Audio file 1 (TRAP_RELAY_FILE.WAV) ▾
<b>Repeat Count (0-15)</b>	<input type="text" value="0"/>
<b>Repeat Delay (0s-2m)</b>	<input type="text" value="1s"/>

< Back    Next >    Cancel

*Provisioning SNMP notification settings*

4c. Enter the appropriate information for Audio notifications in the fields of the Audio Notification screen. Click **Next >** to continue.

Audio Notification	
<b>Audio Output Ports</b>	The output ports where audio notification should be sent.
<b>Audio File</b>	The audio file to be played.
<b>Repeat Count</b>	The number of times audio should be played.
<b>Repeat Delay</b>	The delay between each audio notification.

## 11.7.2 Schedule

Set a schedule for when you'd like the Trap 48 RA to send the notification configured in the previous steps. All schedule settings default to full-time notification, 24 hours a day, 7 days a week.

**Notification 3 (Schedule)**

No.	Sun	Mon	Tue	Wed	Thu	Fri	Sat	Notification Time	
1	<input checked="" type="checkbox"/>	<input checked="" type="checkbox"/>	<input checked="" type="checkbox"/>	<input checked="" type="checkbox"/>	<input checked="" type="checkbox"/>	<input checked="" type="checkbox"/>	<input checked="" type="checkbox"/>	<input type="radio"/> Any Time	<input type="radio"/> 12 h 0 min AM to 11 h 59 min PM
2	<input checked="" type="checkbox"/>	<input checked="" type="checkbox"/>	<input checked="" type="checkbox"/>	<input checked="" type="checkbox"/>	<input checked="" type="checkbox"/>	<input checked="" type="checkbox"/>	<input checked="" type="checkbox"/>	<input type="radio"/> Any Time	<input type="radio"/> 12 h 0 min AM to 11 h 59 min PM

*Fig. 11.14 - The Schedule creation screen*

Notification Scheduling	
<b>Days of the week</b>	From either Schedule 1 or 2, check which days you want to receive notifications.
<b>Any Time</b>	Select to tell the Trap 48 RA you want to receive alarm notifications at any time for the day(s) you've selected.
<b>Notification Time</b>	Instead of "Any Time", use these fields to only send alarm notifications during certain hours on the day(s) you've selected.

When finished, click **Test** to test the notification or **Finish** to save the notification.



## 11.7.3 How to Send Email Notifications

1. Click on the **System** button in the **Provisioning** menu and enter a valid email address in the "**From** **Email Address** field. (You may need to check with your IT department to have one created for the unit.) This is the address that will appear in your email as the sender.

System Settings	
<b>Global System Settings</b>	
Name	Trap 48 RA G2
Location	Fresno, CA
Contact	559-454-1600
Features	FFBA-15-0C5C
"From" E-mail address	traprelay64@dpstele.com
User	admin
Password	.....
<b>SNMP Settings</b>	
Listening Port	162
Get Community	dps
Set Community	dps
Inbound Trap Community	dps
<b>DCP Responder Settings</b> <a href="#">Display Mapping</a>	
DCP Unit ID	1 DCPx ▼
<input type="radio"/> Listen DCP over LAN <input checked="" type="radio"/> Disable Listening	
DCP LAN	2001 UDP ▼
<b>System Controls</b>	
Initialize Configuration	<input type="button" value="Initialize"/>
Backup Configuration	config.bin <input type="button" value="Save"/>
Restore Configuration	<a href="#">Upload</a>
<input type="button" value="Reset"/> <input type="button" value="Save"/>	

2. Click on the **Notifications** button in the **Provisioning** menu. You can setup as many as 8 different notifications. Begin the setup "wizard" by clicking on a notification number. In this example, we'll setup Notification 1 to send emails.

## Notifications

No.	Stat.	Type	Server	Time Window 1	Time Window 2
<a href="#">1</a>	OFF	Audio		Sun,Mon,Tue,Wed,Thu,Fri,Sat,Any Time	Sun,Mon,Tue,Wed,Thu,Fri,Sat,Any Time
<a href="#">2</a>	OFF	SNMP	126.10.218.85	Sun,Mon,Tue,Wed,Thu,Fri,Sat,Any Time	Sun,Mon,Tue,Wed,Thu,Fri,Sat,Any Time
<a href="#">3</a>	OFF	Audio		Sun,Mon,Tue,Wed,Thu,Fri,Sat,Any Time	Sun,Mon,Tue,Wed,Thu,Fri,Sat,Any Time
<a href="#">4</a>	OFF	Audio		Sun,Mon,Tue,Wed,Thu,Fri,Sat,Any Time	Sun,Mon,Tue,Wed,Thu,Fri,Sat,Any Time
<a href="#">5</a>	OFF	Email		Sun,Mon,Tue,Wed,Thu,Fri,Sat,Any Time	Sun,Mon,Tue,Wed,Thu,Fri,Sat,Any Time
<a href="#">6</a>	OFF	Email		Sun,Mon,Tue,Wed,Thu,Fri,Sat,Any Time	Sun,Mon,Tue,Wed,Thu,Fri,Sat,Any Time
<a href="#">7</a>	OFF	Email		Sun,Mon,Tue,Wed,Thu,Fri,Sat,Any Time	Sun,Mon,Tue,Wed,Thu,Fri,Sat,Any Time
<a href="#">8</a>	OFF	Email		Sun,Mon,Tue,Wed,Thu,Fri,Sat,Any Time	Sun,Mon,Tue,Wed,Thu,Fri,Sat,Any Time

3. At the **Notification Setting** screen, use the drop-down menu to choose whether you want notifications for alarms, clears, or both. Now, select the **Send Email** button and click Next.

**Notification 1**

**Notification Setting**

Notification Disabled ▾

Send Email  
 Send SNMP

Next > Cancel

4. At the **Email Notification** screen, you'll enter your email server settings. Enter the **IP address** or **Host Name** of your email server (If using **Host Name**, DNS servers must be configured under the ethernet settings). Enter the **Port Number** (usually 25) and the **"To" Email Address** of the technician that will receive these emails. The "From" E-mail address is set on the "Provisioning > System" menu, and cannot be modified from this menu. Click **Next**.

**Notification 1 (Email)**

**Email Notification**

SMTP Server IP or Host Name	<input type="text"/>
Port No. (Usually Use 25)	65535
"From" E-mail Address	traprelay64@dpstele.com
"To" E-mail Address	<input type="text"/>

< Back Next > Cancel

5. At the **Schedule** screen, you'll select the exact days and times you want to receive email notifications. You can set two schedules per notification. For example, you may want to receive notifications at certain times during the week, and at different hours on the weekend. Use the check boxes to select the days of the week, and select the time from the drop down menus. Click **Finish**. To try a test notification, click the **Test** button (See next step.)

**Notification 3 (Schedule)**

No.	Sun	Mon	Tue	Wed	Thu	Fri	Sat	Notification Time	
1	<input checked="" type="checkbox"/>	<input checked="" type="checkbox"/>	<input checked="" type="checkbox"/>	<input checked="" type="checkbox"/>	<input checked="" type="checkbox"/>	<input checked="" type="checkbox"/>	<input checked="" type="checkbox"/>	<input type="radio"/> Any Time	<input type="text"/> 12 ▾ h 0 ▾ min AM ▾ to 11 ▾ h 59 ▾ min PM ▾
2	<input checked="" type="checkbox"/>	<input checked="" type="checkbox"/>	<input checked="" type="checkbox"/>	<input checked="" type="checkbox"/>	<input checked="" type="checkbox"/>	<input checked="" type="checkbox"/>	<input checked="" type="checkbox"/>	<input type="radio"/> Any Time	<input type="text"/> 12 ▾ h 0 ▾ min AM ▾ to 11 ▾ h 59 ▾ min PM ▾

< Back Finish Test Cancel

6. If you chose to test the email notification you've just setup, you will see a popup. Click **OK** to send a test email notification. Confirm all your settings by checking your email to see if you've received it.

**NOTE:** This test only means that your notification settings are correct, but you still need to assign the notification to an alarm point. See the next step.

7. Now you will associate this notification to a control. You have 8 notification devices available to use. In the image below, you might assign **Notification Device 1** to **Control 1**. This means that you would receive an email notification when "Relay 1" (Control 1) changes state. Remember that Notification #1 in the Notifications menu corresponds to the first "Notifications" column of check boxes. (Notification #2 is the second column, and so on until Notification #8)

**Notifications**

No.	Stat.	Type	Server	Time Window 1	Time Window 2
1	ON	Email	206.169.87.188	Sun,Mon,Tue,Wed,Thu,Fri,Sat,Any Time	Sun,Mon,Tue,Wed,Thu,Fri,Sat,Any Time
2	OFF	Email		Sun,Mon,Tue,Wed,Thu,Fri,Sat,Any Time	Sun,Mon,Tue,Wed,Thu,Fri,Sat,Any Time
3	OFF	Email		Sun,Mon,Tue,Wed,Thu,Fri,Sat,Any Time	Sun,Mon,Tue,Wed,Thu,Fri,Sat,Any Time
4	ON	SNMP	126.10.230.171	Sun,Mon,Tue,Wed,Thu,Fri,Sat,Any Time	Sun,Mon,Tue,Wed,Thu,Fri,Sat,Any Time

**Trap 48RA** [Upload](#) | [Logout](#) | [MyDPS](#)

**Controls**

1-24 | **25-48**

Reset Save

Number	Description	Energized State	Echo Ping	Notifications
1	Server A <a href="#">Advanced&lt;&lt;</a>	<input type="checkbox"/>	<input type="checkbox"/>	<input checked="" type="checkbox"/> <input type="checkbox"/> <input type="checkbox"/> <input type="checkbox"/> <input type="checkbox"/> <input type="checkbox"/> <input type="checkbox"/> <input type="checkbox"/>

Enterprise/OID Generic Specific Variable Binding Value

Set: 1.3.6.1.4.1.2682.1.2 enterpriseSpecific(6) 8001 None

Clear: 1.3.6.1.4.1.2682.1.2.3.3 enterpriseSpecific(6) 9001 None

*Associating Controls to the Notifications Table*

## 11.8 Variable Bindings

Variable bindings for the Trap Relay can be added using the **Provisioning > Variable Bindings** menu. Variable bindings are additional OIDs (supplied by the manufacturer of the product connected to the control relay) used to uniquely identify the SNMP trap. Variable bindings are used as an additional method of identifying SNMP traps. Up to one variable binding can be used per relay or audio output.

Idx	OID
1	0
2	0
3	0
4	0

The Provisioning > Variable Bindings menu

Provisioning Variable Bindings	
<b>Id</b>	Index number of the relay for the binding.
<b>OID</b>	OID of the variable binding. <b>Note:</b> Using a * in this field is like a "wild card" - any value is accepted.

## 11.9 Load Audio Files in G2 Firmware

Audio files can be uploaded from **Provisioning > Load Audio Files** window. The Trap48 RA G2 supports 8 custom audio files to be uploaded.

This feature is not offered in the G1 Firmware version.

**NOTE:** the input audio file must be in WAVE format and must be 12000 Hz u-law encoded.

Load Audio		
Number	Current File	New File
1	<a href="#">TRAP_RELAY_FILE.WAV</a>	Choose File No file chosen Load
2	<a href="#">ileNum</a>	Choose File No file chosen Load
3	<a href="#">ileNum</a>	Choose File No file chosen Load
4	<a href="#">ileNum</a>	Choose File No file chosen Load
5	<a href="#">ileNum</a>	Choose File No file chosen Load
6	not loaded	Choose File No file chosen Load
7	not loaded	Choose File No file chosen Load
8	<a href="#">TRAP_RELAY_FILE2.WAV</a>	Choose File No file chosen Load

## 11.10 Date and Time

**Date and Time**

**Time Settings**

Date: Month **Jan** Day **1** Year **2000**

Time: Hour **2** Minute **40** AM

**Automatic Time Adjustment (NTP)**

Enable NTP

NTP Server Address or Host Name:  Sync

Time Zone: GMT-08:00 Pacific Time

**Adjust Clock for Daylight Saving Time (DST)**

Enable DST

Start Day: Month **Mar** Weekday **Second Sunday** Hour **2** AM

End Day: Month **Nov** Weekday **First Sunday** Hour **2** AM

Reset Save

*The Provisioning > Date and Time menu*

Time Settings	
<b>Date</b>	Select the current month, day, and year from the drop-down menus.
<b>Time</b>	Select the current hour, minutes, and time of day from the drop-down menus.
Automatic Time Adjustment (NTP)	
<b>Enable NTP</b>	Check this box to enable Network Time Protocol.
<b>NTP Server Address or Host Name</b>	Enter the NTP server's IP address or host name, then click Sync. Example: north-america.pool.ntp.org
<b>Time Zone</b>	Select your time zone from the drop-down menu.
Adjust Clock for Daylight Savings Time (DST)	
<b>Enable DST</b>	Check this box to have the Trap Relay 64 observe Daylight Savings.
<b>Start Day</b>	Select the month, weekday, and time when Daylight Savings will begin.
<b>End Day</b>	Select the month, weekday, and time when Daylight Savings will end.

## 11.11 Timers

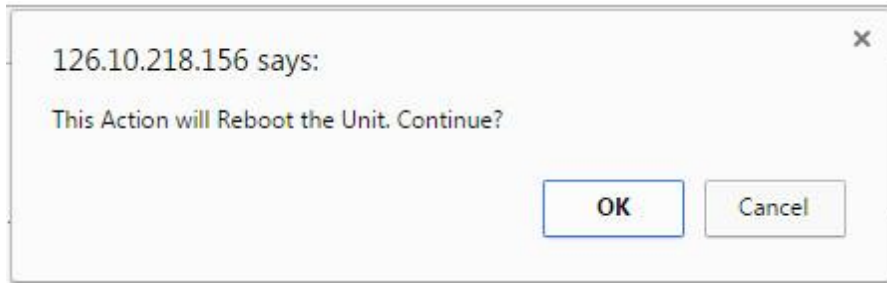
The Timers Menu allows configuration of various intervals, such as delays between pings, audible alarm tone length, and web refresh delay. Each timer is fully explained within the Timers Menu, as shown below:

Timers	
Description	Timer Value
<b>Web Refresh (100ms-60s):</b> How often web browser is refreshed when in monitor mode.	<input type="text" value="1s"/>
<b>Timed Tick (0s-60m 0=off):</b> This is a 'heartbeat' function that can be used by masters who don't perform integrity checks.	<input type="text" value="0s"/>
<b>Ping Cycle (0s-30m):</b> Time interval between each ping cycle (0 disables, 30 seconds minimum)	<input type="text" value="60s"/>

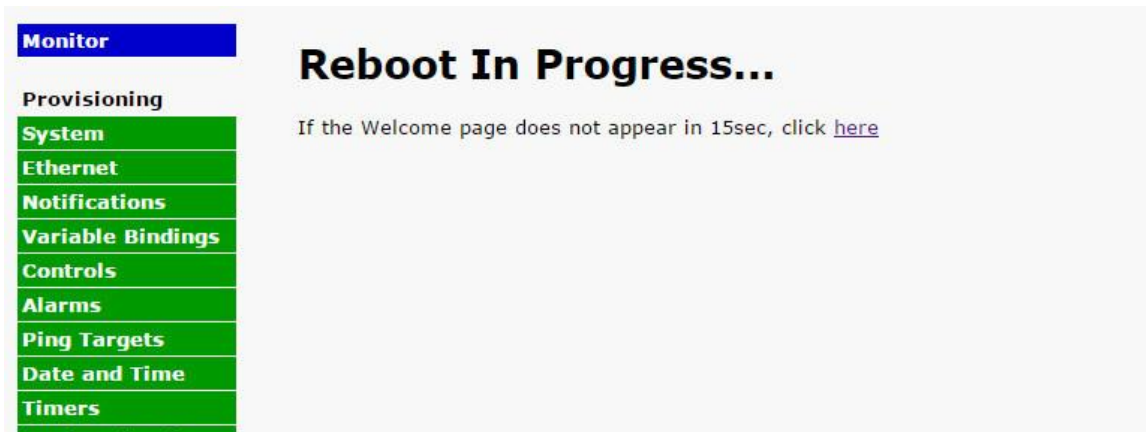
*The Provisioning > Timers menu*

## 12 Reboot

Click *Reboot*.



The above message will appear. Click *OK*.





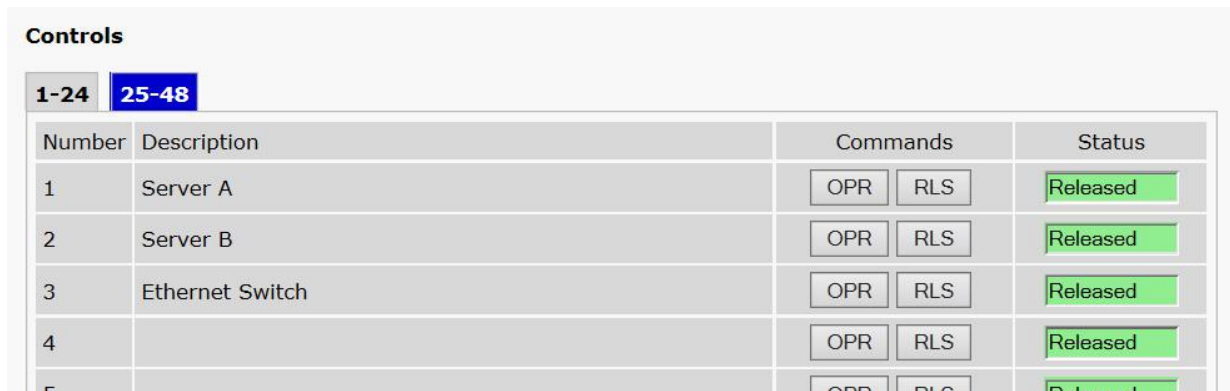
## 13 Monitoring via the Web Browser

### 13.1 Controls

From the Monitor > Controls menu, you can manually operate and release the relay outputs. This is useful for manually testing your relay connections and verifying that your system works.

Use the following rules to operate the Trap 48 RA's control:

1. Select **Controls** from the **Monitor** menu.
2. Under the **State** field, you can see the current condition of the control.
3. Use the **OPR** and **RLS** buttons to operate and release the relays. You can use these buttons to:
  - a. Test the relays
  - b. To manually force the SNMP alarm in a known state and/or synchronize it



The screenshot shows a web interface titled "Controls". At the top, there are two tabs: "1-24" and "25-48". Below the tabs is a table with four columns: "Number", "Description", "Commands", and "Status". The table contains five rows of data. Each row has a "Number" (1-5), a "Description" (Server A, Server B, Ethernet Switch, and two blank entries), "Commands" (OPR and RLS buttons), and a "Status" (Released, shown in a green box).

Number	Description	Commands	Status
1	Server A	OPR RLS	Released
2	Server B	OPR RLS	Released
3	Ethernet Switch	OPR RLS	Released
4		OPR RLS	Released
5		OPR RLS	Released

*Fig 12.1 View the state of the control relays in the Monitor > Controls menu*

## 13.2 Audio

From the Monitor > Audio menu, you can verify the status, as well as control the stopping and starting, of your audio outputs. You can use this menu to emit and adjust sound levels, as well as test your audio outputs and verify their connections.

Use the following rules to operate the Trap 48 RA's audio alarms:

1. Select **Audio** from the **Monitor** menu.
2. Under the **Status** field, you can see the current condition of the audio alarm.
3. Use the **On**, **Off**, and **Disable** buttons to control the audio outputs. Pressing **Disable** will prevent that particular audio output from working. **Note:** You must click **Save** at the bottom in order for the **Disable** setting to remember beyond a unit reboot.

**NOTE:** This feature is not present in *Monitor Mode* of the Trap48 RA G2 web browser.

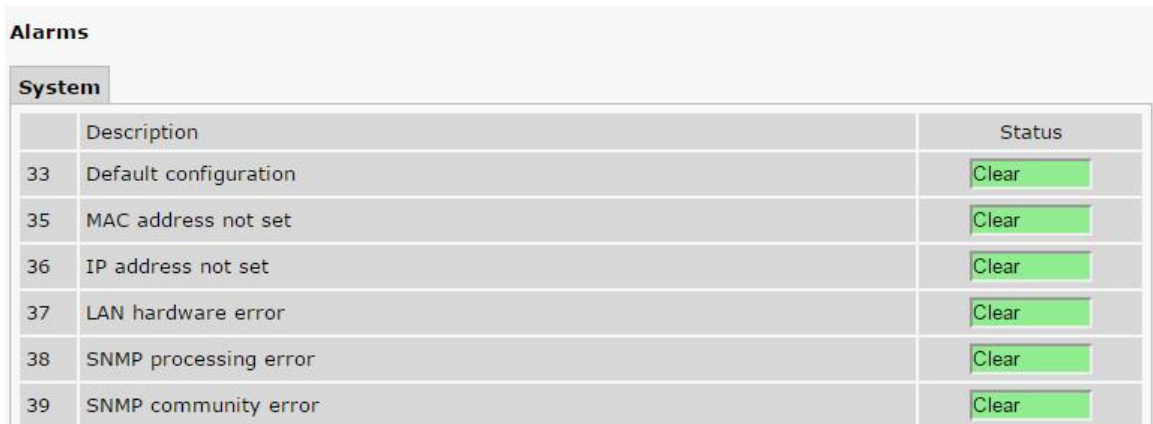
Audio			
1-16			
Number	Description	Commands	Status
1	DEF1.WAV	On Off Disable	Stopped
2	HYDRA_EQPT_ROOM_REPEATER_FAILURE.WAV	On Off Disable	Stopped
3	PORTABLE_COMMS_FAILURE.WAV	On Off Disable	Stopped
4		On Off Disable	Stopped
5		On Off Disable	Stopped
6		On Off Disable	Stopped

**Fig 12.2** View the state of the audio relays in the Monitor > Audio menu

## 13.3 System Alarms

System alarms are non-editable alarms that are programmed into Trap 48 RA. The "System" tab of the **Monitor > Alarms** screen provides the status of the system alarms by indicating if an alarm has been triggered. Under the **State** column, the status will appear in red if an alarm has been activated, or green if it has not been activated. The status will be displayed in green when the alarm condition is not present.

See "Display Mapping" in the Reference Section for a complete description of system alarms.



The screenshot shows the "Alarms" section with a "System" tab selected. Below the tab is a table with three columns: an empty column for ID, "Description", and "Status". The "Status" column contains a green "Clear" button for each row.

	Description	Status
33	Default configuration	Clear
35	MAC address not set	Clear
36	IP address not set	Clear
37	LAN hardware error	Clear
38	SNMP processing error	Clear
39	SNMP community error	Clear

**Fig 12.3** View the status of System Alarms from the Monitor > Alarms menu.

## 13.4 Ping Targets

The Trap 48 RA can support up to 64 ping targets. You can view each the configured ping targets by browsing to the **Monitor > Ping Targets** window.

**Ping Targets**

1-32 **33-64**

ID	Description	IP Address	Status
1		255.255.255.255	Clear
2		255.255.255.255	Clear
3		255.255.255.255	Clear
4		255.255.255.255	Clear
5		255.255.255.255	Clear

*Fig 12.4 The Monitor > Ping Targets interface*

# 14 Firmware Upgrade

Before upgrading the firmware, DPS Telecom suggests that you go to **System Settings >> Backup Configuration** and save your configuration settings. To access the **Firmware Load** screen, click on the upload link at the top right of the browser.

To be notified every time a new firmware is released for your device, login to your My DPS account and navigate to the **Notifications** page. At this page check the box that corresponds to the device that you want firmware notifications for.

The screenshot shows the 'Trap 48RA' configuration page in the DPS Telecom web interface. The page is divided into several sections:

- Monitor Menus:** Controls, Audio, Alarms, Ping Targets.
- Edit Menus:** System, Ethernet, Notifications, Variable Bindings, Controls, Audio, Alarms, Ping Targets, Date and Time, Timers, Reboot.
- System Settings:**
  - Global System Settings:** Name (Trap Relay 64), Location (Fresno, CA), Contact (559-454-1600), "From" E-mail address (APD32@dpstele.com), SNMP Get String (dps\_public), SNMP Set String (dps\_public), SNMP Trap String (dps\_public), User (admin), Password (masked).
  - DCP Responder Settings:** DCP Unit ID (1), Listen DCP over LAN (disabled), DCP LAN (2001).
  - System Controls:** Initialize Configuration (Initialize button), Backup Configuration (config.bin, Save button), Restore Configuration (Upload link).

Fig. 13.1 The clickable link to upgrade firmware from the Provisioning > System menu

At the **Firmware Load** screen, simply browse for the firmware update you've downloaded from [www.dpstele.com](http://www.dpstele.com) and click **Load**.

The screenshot shows the 'Firmware Load' screen in the DPS Telecom web interface. The page features the 'DPS Telecom' logo and the text 'Upload (config, firmware, web, or bundle)'. Below this, there is a text input field, a 'Browse...' button, and an 'Upload' button.

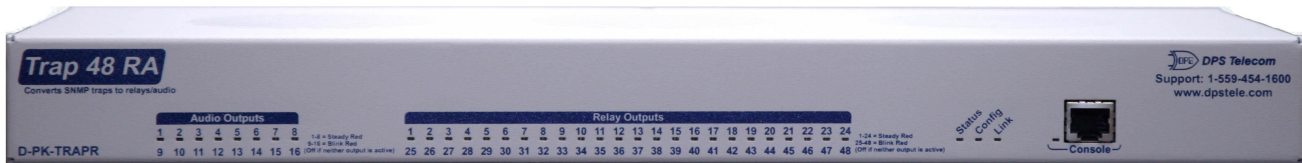
Fig. 13.2 Browse for downloaded firmware upgrade

If you experience any difficulty updating the firmware of your device, contact DPS tech support at 559-454-1600 or at [support@dpstele.com](mailto:support@dpstele.com) for assistance.

**Note:** The firmware upgrade page is only available using HTTP web browse. HTTPS is not supported.

# 15 Reference Section

## 15.1 Front and Back Panel LEDs



**Fig. 14.1** Front panel LEDs

LED	Status	Description
Config	Solid Red	The unit has been configured and needs to be rebooted.
Status	Flashing Green	Trap 48 RA application running.
	Flashing Red	Boot Loader is running.
Link	Solid Green	LAN connected.
	Solid Red	LAN not detected.
Relay Outputs	Solid Red	Relay is active on relay labeled 1-24.
	Flashing Red	Relay is active on relay labeled 25-48.
	Alternating Solid Red and Flashing Red	Relays are active on points labeled 1/25, 2/26 etc.
Audio Outputs	Solid Red	Audio outputs are active on channels labeled 1-8.
	Flashing Red	Audio outputs are active on channels labeled 9-16.
	Alternating Solid Red and Flashing Red	Audio outputs are active on points labeled 1/9, 2/10, etc.
Console	Flashing Green	Trap 48 RA data transmitted over console port.
	Flashing Red	Trap 48 RA data received over console port.

**Table 14.1** Front Panel LED Descriptions



**Fig. 14.2** Back panel LEDs

LED	Status	Description
A	Solid Green	Power supply A OK.
	Off	No voltage, low voltage or incorrect polarity on Power supply A.
B	Solid Green	Power supply B OK.
	Off	No voltage, low voltage or incorrect polarity on Power supply B.
FA	Solid Red	Blown Fuse.
LNK	Solid Green	LAN connected.
LAN	Flashing Yellow	LAN Activity.

**Table 14.2** Back Panel LED Descriptions

## 15.2 Display Mapping

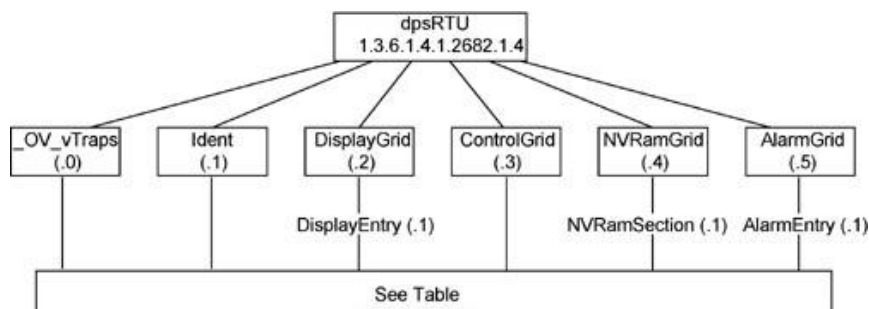
	Description	Port	Address	Point
Display 1	Default configuration	99	1	33
	MAC address not set	99	1	35
	IP address not set	99	1	36
	LAN hardware error	99	1	37
	SNMP processing error	99	1	38
	SNMP community error	99	1	39
	LAN TX packet drop	99	1	40
	Notification 1 failed	99	1	41
	Notification 2 failed	99	1	42
	Notification 3 failed	99	1	43
	Notification 4 failed	99	1	44
	NTP failed	99	1	49
	Timed Tick	99	1	50
	Dynamic memory full	99	1	52
	Unit Reset	99	1	53
Display 2	Controls 1-48	99	1	1-48
	Audio Alarms 1-16	99	1	49-64
Display 3	Ping Targets 1-64	99	1	1-64

*Table 14.3 Display Mapping*

## 15.3 SNMP Manager Functions

**Note:** The Trap 48 RA appears like an SNMP Agent to other managers. Use this section for interfacing the Trap 48 RA to other managers.

The SNMP Manager allows the user to view alarm status, set date/time, issue controls, and perform a resync. The display and tables below outline the MIB object identifiers. Table 14.3 begins with dpsRTU; however, the MIB object identifier tree has several levels above it. The full English name is as follows: root.iso.org.dod.internet.private.enterprises.dps-Inc.dpsAlarmControl.dpsRTU. Therefore, dpsRTU's full object identifier is 1.3.6.1.4.1.2682.1.4. Each level beyond dpsRTU adds another object identifying number. For example, the object identifier of the Display portion of the Control Grid is 1.3.6.1.4.1.2682.1.4.3.3 because the object identifier of dpsRTU is 1.3.6.1.4.1.2682.1.4 + the Control Grid (.3) + the Display (.3).



*Table 14.4*



<b>Tbl. B1 (O.)_OV_Traps points</b>	<b>Tbl. B2 (.1) Identity points</b>	<b>Tbl. B3 (.2) DisplayGrid points</b>
<b>_OV_vTraps (1.3.6.1.4.1.2682.1.4.0)</b>	<b>Ident (1.3.6.1.4.1.2682.1.4.1)</b>	<b>DisplayEntry (1.3.6.1.4.1.2682.1.4.2.1)</b>
PointSet (.20)	Manufacturer (.1)	Port (.1)
PointClr (.21)	Model (.2)	Address (.2)
SumPSet (.101)	Firmware Version (.3)	Display (.3)
SumPClr (.102)	DateTime (.4)	DispDesc (.4)*
ComFailed (.103)	ResyncReq (.5)*	PntMap (.5)*
ComRestored (.014)	* Must be set to "1" to perform the resync request which will resend TRAPs for any standing alarm.	
P0001Set (.10001) through P0064Set (.10064)		
P0001Clr (.20001) through P0064Clr (.20064)		
<b>Tbl. B3 (.3) ControlGrid points</b>		<b>Tbl. B5 (.5) AlarmEntry points</b>
<b>ControlGrid (1.3.6.1.4.1.2682.1.4.3)</b>		<b>AlarmEntry (1.3.6.4.1.2682.1.4.5.1)</b>
Port (.1)		Aport (.1)
Address (.2)		AAddress (.2)
Display (.3)		ADisplay (.3)
Point (.4)		APoint (.4)
Action (.5)		APntDesc (.5)*
		AState (.6)
		* For specific alarm points, see Table B6

**Table 14.5**

The Trap Relay 64 OID has changed from 1.3.6.1.4.1.2682.1.2 to 1.3.6.1.4.1.2682.1.4 Updated MIB files are available on the Resource CD or upon request.

## 15.4 SNMP Granular Trap Packets (Outbound)

Tables 14.5 and 14.6 provide a list of the information contained in the SNMP Trap packets sent by the Trap 48 RA.

**SNMP Trap managers can use one of two methods to get alarm information:**

1. Granular traps (not necessary to define point descriptions for the Trap 48 RA) **OR**
2. The SNMP manager reads the description from the Trap.

UDP Header	Description
1238	Source port
162	Destination port
303	Length
0xBAB0	Checksum

**Table 14.6** UDP Headers and descriptions

SNMP Header	Description
0	Version
Public	Request
Trap	Request
1.3.6.1.4.1.2682.1.4	Enterprise
126.10.230.181	Agent address
Enterprise Specific	Generic Trap
8001	Specific Trap
617077	Time stamp
1.3.7.1.2.1.1.1.0	Object
NetGuardian v1.0K	Value
1.3.6.1.2.1.1.6.0	Object
1-800-622-3314	Value
1.3.6.1.4.1.2682.1.4.4.1.0	Object
01-02-1995 05:08:27.760	Value
1.3.6.1.4.1.2682.1.4.5.1.1.99.1.1.1	Object
99	Value
1.3.6.1.4.1.2682.1.4.5.1.2.99.1.1.1	Object
1	Value
1.3.6.1.4.1.2682.1.4.5.1.3.99.1.1.1	Object
1	Value
1.3.6.1.4.1.2682.1.4.5.1.4.99.1.1.1	Object
1	Value
1.3.6.1.4.1.2682.1.4.5.1.5.99.1.1.1	Object
Rectifier Failure	Value
1.3.6.1.4.1.2682.1.4.5.1.6.99.1.1.1	Object
Alarm	Value

**Table 14.7** SNMP Headers and descriptions

## 16 Frequently Asked Questions

Here are answers to some common questions from Trap 48 RA users. The latest FAQs can be found on the Trap 48 RA support web page, <http://www.dpstele.com>.

If you have a question about the Trap 48 RA, please call us at **(559) 454-1600** or e-mail us at [support@dpstele.com](mailto:support@dpstele.com)

### 16.1 General FAQs

**Q. How do I telnet to the Trap 48 RA?**

**A.** You must use **Port 2002** to connect to the Trap 48 RA. Configure your Telnet client to connect using TCP/IP (**not** "Telnet," or any other port options). For connection information, enter the IP address of the Trap 48 RA and Port 2002. For example, to connect to the Trap 48 RA using the standard Windows Telnet client, click Start, click Run, and type "telnet <Trap 48 RA IP address> 2002."

**Q. How do I connect my Trap 48 RA to the LAN?**

**A.** To connect your Trap 48 RA to your LAN, you need to configure the unit IP address, the subnet mask and the default gateway. A sample configuration could look like this:

**Unit Address:** 192.168.1.100

**subnet mask:** 255.255.255.0

**Default Gateway:** 192.168.1.1

Save your changes by writing to NVRAM and reboot. Any change to the unit's IP configuration requires a reboot.

**Q. When I connect to the Trap 48 RA through the craft port on the front panel it either doesn't work right or it doesn't work at all. What's going on?**

**A.** Make sure your using the right COM port settings. Your COM port settings should read:

**Bits per second:** 9600 (9600 baud)

**Data bits:** 8

**Parity:** None

**Stop bits:** 1

**Flow control:** None

**Important!** Flow control **must** be set to **none**. Flow control normally defaults to hardware in most terminal programs, and this will not work correctly with the Trap 48 RA.

**Q. The LAN link LED is green on my Trap 48 RA, but I can't poll it from my T/Mon.**

**A.** Some routers will not forward packets to an IP address until the MAC address of the destination device has been registered on the router's Address Resolution Protocol (ARP) table. Enter the IP address of your gateway and your T/Mon system to the ARP table.

**Q. I'm unsure if the voltage of my power supply is within the specified range. How do I test the voltage?**

**A.** Connect the black common lead of a voltmeter to the ground terminal of the battery. Connect the red lead of the voltmeter to the batter's VCD terminal. The voltmeter should read between +12 and +24VDC for +12VDC build.

## 16.2 SNMP FAQs

**Q. Which version of SNMP is supported by the SNMP agent on the Trap 48 RA?**

**A.** SNMP v1 and SNMPv2c.

**Q. How do I configure the Trap 48 RA to send traps to an SNMP manager? Is there a separate MIB for the Trap 48 RA? How many SNMP managers can the agent send traps to? And how do I set the IP address of the SNMP manager and the community string to be used when sending traps?**

**A.** The Trap 48 RA begins sending traps as soon as the SNMP managers are defined. The Trap 48 RA MIB is included on the Trap 48 RA Resource CD. The MIB should be compiled on your SNMP manager. (**Note:** MIB versions may change in the future.) The unit supports 2 SNMP managers, which are configured by entering its IP address in the Trap Address field of Ethernet Port Setup. To configure the community strings, choose SNMP from the Provisioning menu, and enter appropriate values in the Get, Set, and Trap fields.

**Q. Does the Trap 48 RA support MIB-2 and/or any other standard MIBs?**

**A.** The Trap 48 RA supports the bulk of MIB-2.

**Q. Does the Trap 48 RA SNMP agent support both Trap 48 RA and T/MonXM variables?**

**A.** The Trap 48 RA SNMP agent manages an embedded MIB that supports only the Trap 48 RA's RTU variables. The T/MonXM variables are included in the distributed MIB only to provide SNMP managers with a single MIB for all DPS Telecom products.

**Q. How many traps are triggered when a single point is set or cleared? The MIB defines traps like "major alarm set/cleared," "RTU point set," and a lot of granular traps, which could imply that more than one trap is sent when a change of state occurs on one point.**

**A.** Generally, a single change of state generates a single trap.

**Q. What does "point map" mean?**

**A.** A point map is a single MIB leaf that presents the current status of a 64-alarm-point display in an ASCII-readable form, where a "." represents a clear and an "x" represents an alarm.

**Q. The Trap 48 RA manual talks about control relay outputs. How do I control these from my SNMP manager?**

**A.** The control relays are operated by issuing the appropriate set commands, which are contained in the DPS Telecom MIB.

**Q. How can I associate descriptive information with a point for the RTU granular traps?**

**A.** The Trap 48 RA control point descriptions are individually defined using the Web Browser.

**Q. My SNMP traps aren't getting through. What should I try?**

**A.** Try these three steps:

1. Make sure that the Trap Address (IP address of the SNMP manager) is defined. (If you changed the Trap Address, make sure you saved the change to NVRAM and rebooted.)
2. Make sure all alarm points are configured to send SNMP traps.
3. Make sure the Trap 48 RA and the SNMP manager are both on the network. Use the unit's ping command to ping the SNMP manager.

# 17 Technical Support

DPS Telecom products are backed by our courteous, friendly Technical Support representatives, who will give you the best in fast and accurate customer service. To help us help you better, please take the following steps before calling Technical Support:

## 1. Check the DPS Telecom website.

You will find answers to many common questions on the DPS Telecom website, at <http://www.dpstele.com/support/>. Look here first for a fast solution to your problem.

## 2. Prepare relevant information.

Having important information about your DPS Telecom product in hand when you call will greatly reduce the time it takes to answer your questions. If you do not have all of the information when you call, our Technical Support representatives can assist you in gathering it. Please write the information down for easy access. Please have your user manual and hardware serial number ready.

## 3. Have access to troubled equipment.

Please be at or near your equipment when you call DPS Telecom Technical Support. This will help us solve your problem more efficiently.

## 4. Call during Customer Support hours.

Customer support hours are Monday through Friday, from 7 A.M. to 6 P.M., Pacific time. The DPS Telecom Technical Support phone number is **(559) 454-1600**.

**Emergency Assistance:** *Emergency assistance is available 24 hours a day, 7 days a week. For emergency assistance after hours, allow the phone to ring until it is answered with a paging message. You will be asked to enter your phone number. An on-call technical support representative will return your call as soon as possible.*

## 18 End User License Agreement

All Software and firmware used in, for, or in connection with the Product, parts, subsystems, or derivatives thereof, in whatever form, including, without limitation, source code, object code and microcode, including any computer programs and any documentation relating to or describing such Software is furnished to the End User only under a non-exclusive perpetual license solely for End User's use with the Product.

The Software may not be copied or modified, in whole or in part, for any purpose whatsoever. The Software may not be reverse engineered, compiled, or disassembled. No title to or ownership of the Software or any of its parts is transferred to the End User. Title to all patents, copyrights, trade secrets, and any other applicable rights shall remain with the DPS Telecom.

DPS Telecom's warranty and limitation on its liability for the Software is as described in the warranty information provided to End User in the Product Manual.

End User shall indemnify DPS Telecom and hold it harmless for and against any and all claims, damages, losses, costs, expenses, obligations, liabilities, fees and costs and all amounts paid in settlement of any claim, action or suit which may be asserted against DPS Telecom which arise out of or are related to the non-fulfillment of any covenant or obligation of End User in connection with this Agreement.

This Agreement shall be construed and enforced in accordance with the laws of the State of California, without regard to choice of law principles and excluding the provisions of the UN Convention on Contracts for the International Sale of Goods. Any dispute arising out of the Agreement shall be commenced and maintained only in Fresno County, California. In the event suit is brought or an attorney is retained by any party to this Agreement to seek interpretation or construction of any term or provision of this Agreement, to enforce the terms of this Agreement, to collect any money due, or to obtain any money damages or equitable relief for breach, the prevailing party shall be entitled to recover, in addition to any other available remedy, reimbursement for reasonable attorneys' fees, court costs, costs of investigation, and other related expenses.

# Warranty

---

DPS Telecom warrants, to the original purchaser only, that its products a) substantially conform to DPS' published specifications and b) are substantially free from defects in material and workmanship. This warranty expires two years from the date of product delivery with respect to hardware and ninety days from the date of product delivery with respect to software. If the purchaser discovers within these periods a failure of the product to substantially conform to the specifications or that the product is not substantially free from defects in material and workmanship, the purchaser must promptly notify DPS. Within reasonable time after notification, DPS will endeavor to correct any substantial non-conformance with the specifications or substantial defects in material and workmanship, with new or used replacement parts. All warranty service will be performed at the company's office in Fresno, California, at no charge to the purchaser, other than the cost of shipping to and from DPS, which shall be the responsibility of the purchaser. If DPS is unable to repair the product to conform to the warranty, DPS will provide at its option one of the following: a replacement product or a refund of the purchase price for the non-conforming product. These remedies are the purchaser's only remedies for breach of warranty. Prior to initial use the purchaser shall have determined the suitability of the product for its intended use. DPS does not warrant a) any product, components or parts not manufactured by DPS, b) defects caused by the purchaser's failure to provide a suitable installation environment for the product, c) damage caused by use of the product for purposes other than those for which it was designed, d) damage caused by disasters such as fire, flood, wind or lightning unless and to the extent that the product specification provides for resistance to a defined disaster, e) damage caused by unauthorized attachments or modifications, f) damage during shipment from the purchaser to DPS, or g) any abuse or misuse by the purchaser.

THE FOREGOING WARRANTIES ARE IN LIEU OF ALL OTHER WARRANTIES, EXPRESS OR IMPLIED, INCLUDING BUT NOT LIMITED TO THE IMPLIED WARRANTIES OF MERCHANTABILITY AND FITNESS FOR A PARTICULAR PURPOSE.

In no event will DPS be liable for any special, incidental, or consequential damages based on breach of warranty, breach of contract, negligence, strict tort, or any other legal theory. Damages that DPS will not be responsible for include but are not limited to, loss of profits; loss of savings or revenue; loss of use of the product or any associated equipment; cost of capital; cost of any substitute equipment, facilities or services; downtime; claims of third parties including customers; and injury to property.

The purchaser shall fill out the requested information on the Product Warranty Card and mail the card to DPS. This card provides information that helps DPS make product improvements and develop new products.

For an additional fee DPS may, at its option, make available by written agreement only an extended warranty providing an additional period of time for the applicability of the standard warranty.

## Technical Support

If a purchaser believes that a product is not operating in substantial conformance with DPS' published specifications or there appear to be defects in material and workmanship, the purchaser should contact our technical support representatives. If the problem cannot be corrected over the telephone and the product and problem are covered by the warranty, the technical support representative will authorize the return of the product for service and provide shipping information. If the product is out of warranty, repair charges will be quoted. All non-warranty repairs receive a 90-day warranty.

# Free Tech Support is Only a Click Away

Need help with your alarm monitoring? DPS Information Services are ready to serve you ... in your email or over the Web!

[www.DpsTele.com](http://www.DpsTele.com)



## Free Tech Support in Your Email: The Protocol Alarm Monitoring Ezine

The Protocol Alarm Monitoring Ezine is your free email tech support alert, delivered directly to your in-box every two weeks. Every issue has news you can use right away:

- Expert tips on using your alarm monitoring equipment — advanced techniques that will save you hours of work
- Educational White Papers deliver fast informal tutorials on SNMP, ASCII processing, TL1 and other alarm monitoring technologies
- New product and upgrade announcements keep you up to date with the latest technology
- Exclusive access to special offers for DPS Telecom Factory Training, product upgrade offers and discounts

To get your free subscription to The Protocol register online at [www.TheProtocol.com/register](http://www.TheProtocol.com/register)

## Free Tech Support on the Web: MyDPS

MyDPS is your personalized, members-only online resource. Registering for MyDPS is fast, free, and gives you exclusive access to:

- Firmware and software downloads and upgrades
- Product manuals
- Product datasheets
- Exclusive user forms

Register for MyDPS online at [www.DpsTele.com/register](http://www.DpsTele.com/register)

**The Protocol Alarm Monitoring Ezine**  
May 10, 2005 Call: 1-888-393-1060 DPS Telecom

**White Paper: 5 Steps to Intelligent SNMP-Legacy Integration**  
Learn how to make your current alarm monitoring equipment compatible with any SNMP manager — without losing time, money or functionality.  
[Download White Paper](#)

**Turbocharge Your NetGuardian With SNMP v2c**  
The new NetGuardian 4.0 firmware adds SNMP v2c support, robust message delivery via SNMP INFORM command, customizable alarm severity levels and alarm point grouping, plus a whole lot more. Get the full details on everything that's new and how you can upgrade to NetGuardian 4.0. [Read Full Story](#)

**Creative Solution: Convert Your LEDs to Contact Closures**  
Ted Van Tuyl of Click! Network created a unique monitoring application that converts LEDs to contact closures, using DPS equipment.  
[Read Full Story](#)

**DPS Telecom** Call: 1-800-693-0351

**Network Alarm Monitoring Fundamentals**  
**Alarm Monitoring — Where Do You Start?**

You've just been put in charge of purchasing, selecting or recommending a new network alarm system for your company. Where do you start? What alarm equipment do you need? What monitoring features are essential, and which can you live without? How can you make sure your network is fully protected, without spending too much on equipment you won't use?

This White Paper is a quick guide to how you can answer these questions for yourself. This paper will NOT tell you, "Just buy this system and everything will be fine." Every network is different. A one-size fits-all system won't provide the specific coverage you need and may cost more money than you really need to spend.

[Download This White Paper Now!](#)

Name:   
Email:  [Give It To Me!](#)

Remember that we'll NEVER sell your email address to anybody, and that's a promise! We will also send you our informative eMagazine.

**About DPS Telecom**  
Industries Served  
News & Press Releases  
Contact Information  
DPS Departments  
Sales Representatives  
Trade Shows & Events  
Factory Training Events  
Client Testimonials  
Client Success Stories  
Career Opportunities

**Magazine Sign-up**  
Name:   
E-mail:   
[Subscribe](#)  
[View past issues](#)  
[Subscription options](#)

